

SCOOTER-PARTS

Beta Gilera

MBK

Malaguti

Piaggio

Yamaha

Kymco

Cagiva

Suzuki

Peugeot

Honda

Benelli

Italjet

Derbi

Aprilia

Inhaltsverzeichnis

	von	bis *
<i>Auspuffanlage</i>	618	626
<i>Benzinhahnen</i>	635	
<i>Blinker</i>	633	
<i>Bremsen (Beläge Scheiben Kupplung Glocke)</i>	552	592
<i>Dichtungs - Satz</i>	619	628
<i>Griffe</i>	633	634
<i>Handschützer</i>	652	
<i>Helme HJC</i>	648	651
<i>Keilriemen Dayco</i>	593	618
<i>Luftfilter</i>	619	632
<i>Pneu Reifen Heidenau</i>	644	647
<i>Schlösser</i>	634	635
<i>Schutzhülle Knieschutz</i>	652	
<i>Simmerring - Satz</i>	619	627
<i>Ständer (Zentral + Seite)</i>	637	643
<i>Verkauf und Lieferbedingungen</i>	653	
<i>Zündkerzen NGK</i>	636	



Scooter-Beläge + Backen + Kupplung + Glocke Plaquette + mâchoire-Scooter

98

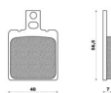
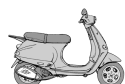

Aprilia	CC	Jahr	Beläge VR	Beläge HR	Scheibe VR	Scheibe HR	Jahr	Kupplung	Glocke
AF1									
	50 cc all Models	1987>	FD.0098	FD.0048	*****	*****	*****	*****	*****
	50 cc Futura	1990>	FD.0098	FD.0048	****	*****	*****	*****	*****
	50 cc Europa	1991>	FD.0098	FD.0048	*****	*****	*****	*****	*****
	125 CC	1987>	FD.0113	FD.0012	*****	*****	*****	*****	*****
	125 CC Replica + Sintesi	1989>1991	FD.0115	FD.0012	*****	*****	*****	*****	*****
	125 CC Futura + Europa	1990>1991	FD.0115	FD.0012	*****	*****	*****	*****	*****
Amico LK/LX/GL/Sport									
	50 cc	1990>1991	GF.0255	GF.0255	()	()	1990>1995	FC.1331	G.0683
	50 cc	1992>	FD.0196	GF.0255	DF.4004	()	1996>	FC.1349	G.0684
Area 51									
	50 cc	1998>	FD.0196	FD.0196	DF.4001	*****	*****	*****	*****
Arecife									
	125 cc	2003>	FD.0282	FD.0267	DF.4038	*****	*****	*****	*****
	200 cc	2003>	FD.0282	FD.0267	DF.4038	*****	*****	*****	*****
	500 cc SX	2002>	FD.0091	FD.0267	DF.4038	*****	2002>	FC.1366	G.0708
	500 cc DX	2002>	FD.0335	*****	DF.4038	*****	2002>	FC.1366	G.0708
Atlantic									
	125 cc (Grimeca)	2003>2005	FD.0282	FD.0267	DF.4038	*****	*****	*****	*****
	200 cc (Grimeca)	2003>2005	FD.0282	FD.0267	DF.4038	*****	*****	*****	*****
	250 cc (Grimeca)	2003>2005	FD.0282	FD.0267	*****	*****	*****	*****	*****
	500 CC PINZA SX	2002>	FD.0091	FD.0267	DF.4038	DF.4037	2002>	FC.1366	G.0708
	500 CC PINZA DX	2002>	FD.0335	*****	DF.4038	DF.4037	2002>	FC.1366	G.0708
	500 CC SPRINT	2005>	FD.0282	FD.0267	DF.4038	DF.4037	*****	*****	*****
Classic									
	50 cc	1992>	FD.0195	GF.0244	*****	()	*****	*****	*****
	80 cc	1993>	FD.0098	GF.0244	*****	()	*****	*****	*****
	125 CC	1996>	FD.0162	FD.0012	*****	****	*****	*****	*****
Gulliver Air/LC									
	50 cc	1995>	FD.0196	GF.0255	DF.4001	()	1995>1996	FC.1331	G.0683
	50 cc	1995>	FD.0196	GF.0255	DF.4001	()	1997>	FC.1349	G.0684
Habana/Custom									
	50 cc	1998>	FD.0196	GF.1308	DF.4001	()	*****	*****	*****
	125 cc	1998>	FD.0271	GF.0268	DF.4001	()	*****	*****	*****
Leonardo									
	125 CC	1995>1996	FD.0012	FD.0196	DF.4017	DF.4001	*****	*****	*****
	125 CC	1997>1998	FD.0263	FD.0196	DF.4017	DF.4001	1998>	FC.1358	G.0702
	125 CC	1999>	FD.0271	FD.0271	DF.4017	DF.4001	1998>	FC.1358	G.0702
	150 CC	1997>1998	FD.0263	FD.0196	DF.4017	DF.4001	1998>	FC.1358	G.0702
	150 CC	1999>	FD.0271	FD.0271	DF.4017	DF.4001	1998>	FC.1358	G.0702
	250 CC	1999>	FD.0091	FD.0267	DF.4017	DF.4037	1998>	FC.1351	G.0698
	300 cc	2002>	FD.0091	FD.0267	*****	*****	*****	*****	*****



Scooter-Beläge + Backen + Kupplung + Glocke Plaquette + mâchoire-Scooter

98

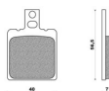
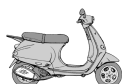

Aprilia	CC	Jahr	Beläge VR	Beläge HR	Scheibe VR	Scheibe HR	Jahr	Kupplung	Glocke
Mojito									
	50 cc	2003>2005	FD.0196	GF.1308	*****	()	*****	*****	*****
	125 cc all Model	1999>2004	FD.0271	FD.0271	*****	*****	*****	*****	*****
	150 cc all Model	2003>2004	FD.0271	FD.0271	*****	*****	*****	*****	*****
MX									
	50 cc	2000>	FD.0195	FD.0048	*****	*****	*****	*****	*****
Rally									
	50 cc	1995	FD.0196	GF.0255	DF.4001	()	1995>1996	FC.1331	G.0683
	50 CC Liquid Cooled	1996>	FD.0196	FD.0196	DF.4001	*****	1996>	FC.1349	G.0684
RS									
	50 cc	1993>1998	FD.0012	FD.0048	DF.4039	*****	*****	*****	*****
	50 cc	1999>	FD.0195	FD.0048	DF.4039	*****	*****	*****	*****
	125 cc EXTREMA+REPLICA	1993>	FD.0115	FD.0012	*****	*****	*****	*****	*****
	250 cc	1995>1996	FD.0093	FD.0012	*****	DF.5071	*****	*****	*****
	250 cc	1997	FD.0093	FD.0196	*****	DF.5071	*****	*****	*****
	250 cc	1998>	FD.0221	FD.0196	*****	DF.5071	*****	*****	*****
	250 cc PISTA	2004>	FD.0221	FD.0196	*****	DF.5071	*****	*****	*****
Scarabeo									
	50 cc	1994>1995	GF.0262	GF.0255	()	()	1994>1995	FC.1331	G.0683
	50 cc	1996>	FD.0196	GF.0255	DF.4010	()	1996>	FC.1349	G.0684
	50 cc	1998>2005	FD.0196	FD.0196	DF.4018	DF.4001	*****	*****	*****
	70 cc	1994	FD.0196	GF.0255	*****	()	*****	*****	*****
	100 cc Minarelli	2000>	FD.0271	GF.1105	*****	()	*****	*****	*****
	100 cc Yamaha	2000>	FD.0271	GF.1303	DF.4018	()	2000>	FC.1340R	G.0688
	100 cc 4T	2001-2004	FD.0271	FD.0267	DF.4018	*****	*****	*****	*****
	125 cc	1998>	FD.0091	FD.0267	DF.4038	DF.4017	1998>	FC.1358	G.0702
	125 cc Piaggio	2003	FD.0091	FD.0267	DF.4038	DF.4017	*****	*****	*****
	125 cc	2004>2005	FD.0091	FD.0267	DF.4038	DF.4017	*****	*****	*****
	150 cc	1998>	FD.0091	FD.0267	DF.4038	DF.4017	*****	*****	*****
	200 cc	2001>	FD.0091	FD.0267	DF.4038	DF.4017	1998>	FC.1358	G.0702
	200 cc Piaggio	2003>	FD.0091	FD.0267	DF.4038	DF.4017	*****	*****	*****
	250 cc	2004>2005	FD.0091	FD.0267	DF.4038	DF.4017	*****	*****	*****
	500 cc	2002>	FD.0091	FD.0267	DF.4038	DF.4037	2002>	FC.1366	G.0708
Scarabeo Di Tech									
	50 cc	2001>2004	FD.0196	FD.0267	*****	*****	*****	*****	*****
Sonic all Model									
	50 cc	1997>	FD.0196	GF.0255	DF.4004	()	1998>	FC.1349	G.0684
Sport City									
	125 cc CITY (Grimeca)	2004>2005	FD.0091	FD.0091	*****	*****	*****	*****	*****
	200 cc PRO	1993>	FD.0115	FD.0012	*****	*****	*****	*****	*****
	200 cc Grimeca	2004-2006	FD.0091	FD.0091	*****	*****	*****	*****	*****
SR									
	50 cc all Models	1993>1996	FD.0197	GF.0255	DF.4001	()	1993>1995	FC.1331	G.0683
	50 cc all Models	1993>1996	FD.0197	GF.0255	DF.4001	()	1996>	FC.1349	G.0684
	50 cc WWW-NETSCAPER	1997>	FD.0196	FD.0196	*****	*****	1997>	FC.1349	G.0684
	50 cc STEALTH-RACING	1997>	FD.0196	FD.0196	*****	*****	1997>	FC.1349	G.0684
	50 cc 2000-IE DITECH	2000>	FD.0196	FD.0267	*****	*****	*****	*****	*****
	50 cc R FACTORY (Grimeca)	2004>2005	FD.0012	FD.0267	*****	*****	*****	*****	*****
	125 cc	1999>	FD.0271	GF.0268	*****	()	1999>	FC.1354	G.0689
	125 cc REPLICA	2000>	FD.0271	*****	*****	*****	*****	*****	*****
	150 cc	1999>	FD.0271	GF.0268	DF.4001	()	1999>	FC.1354	G.0689
	180 cc	2000>	FD.0271	*****	*****	*****	*****	*****	*****



Scooter-Beläge + Backen + Kupplung + Glocke Plaquette + mâchoire-Scooter

98

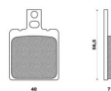

Benelli	CC	Jahr	Beläge VR	Beläge HR	Scheibe VR	Scheibe HR	Jahr	Kupplung	Glocke
Velvet									
	125 cc	1999>	FD.0196	FD.0196	DF.5071	*****	*****	*****	*****
	150 cc	1999>	FD.0196	FD.0196	DF.5071	*****	2001>	FC.1361	G.0698
	250 cc	1999>	FD.0195	FD.0267	DF.5071	*****	*****	*****	*****
Beta Motor	CC	Jahr	Beläge VR	Beläge HR	Scheibe VR	Scheibe HR	Jahr	Kupplung	Glocke
Ark/Ark LC/K									
	50 cc	1996>	FD.0196	FD.0196	*****	*****	>1996	FC.1331	G.0683
	50 cc	1996>	FD.0196	FD.0196	*****	*****	1996>	FC.1349	G.0684
Eikon									
	50 cc	1999>	FD.0094	FD.0094	*****	*****	*****	*****	*****
Quadro/Crono 502+13									
	50 cc	1996>	FD.0196	GF.0255	DF.4001	()	1994>	FC.1331	G.0683
Crono									
	50 cc	1992>1994	FD.0098	GF.0255	DF.4001	()	1993>1994	FC.1331	G.0683
	50 cc	1992>1994	FD.0098	GF.0255	DF.4001	()	1996>	FC.1349	G.0684
Tempo									
	50 cc	1993>	FD.0098	GF.0255	*****	()	1993	FC.1331	G.0683
Cagiva	CC	Jahr	Beläge VR	Beläge HR	Scheibe VR	Scheibe HR	Jahr	Kupplung	Glocke
City									
	50 cc	1992>1994	FD.0173	GF.0255	DF.4006	()	1992>	FC.1333	G.0685
City									
	50 cc	1995>	FD.0219	GF.0255	DF.4006	()	1992>	FC.1333	G.0685
CPI	CC	Jahr	Beläge VR	Beläge HR	Scheibe VR	Scheibe HR	Jahr	Kupplung	Glocke
BABY J									
	50 cc	2002>	FD.0085	GF.1200	*****	()	*****	*****	*****
GTR									
	50 cc	2002	FD.0195	FD.0249	*****	*****	*****	*****	*****
	50 cc	2003>2005	FD.0256	FD.0249	*****	*****	*****	*****	*****
	125 cc	2002	FD.0195	FD.0249	*****	*****	*****	*****	*****
	200 cc	2002	FD.0195	FD.0249	*****	*****	*****	*****	*****
GTS									
	50 cc	2002>2003	FD.0195	FD.0249	*****	*****	*****	*****	*****
	125 cc	2002>2003	FD.0195	FD.0249	*****	*****	*****	*****	*****
	200 cc	2002>2003	FD.0195	FD.0249	*****	*****	*****	*****	*****
HUSSAR									
	50 cc	2001>2002	FD.0085	GF.1200	*****	()	*****	*****	*****
	50 cc	2003>2005	FD.0223	GF.1200	*****	()	*****	*****	*****
MARS									
	50 cc	2001>2002	FD.0085	GF.1200	*****	()	*****	*****	*****
OLIVER									
	50 cc	2003>2005	FD.0223	GF.1200	*****	()	*****	*****	*****
POPCORN									
	50 cc	2002	FD.0085	GF.1200	*****	()	*****	*****	*****
	50 cc	2003>2005	FD.0223	GF.1188	*****	()	*****	*****	*****
SUPERCROSS									
	50 cc	2003>2005	FD.0094	FD.0094	*****	*****	*****	*****	*****
SUPERMOTO									
	50 cc	2003>2005	FD.0094	FD.0094	*****	*****	*****	*****	*****
PRINCE									
	125 cc	2001>	FD.0197	*****	*****	*****	*****	*****	*****
SAUEL									
	125 cc	2002>	FD.0193	FD.0114	*****	*****	*****	*****	*****



Scooter-Beläge + Backen + Kupplung + Glocke Plaquette + mâchoire-Scooter

98

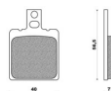

CPI	CC	Jahr	Beläge VR	Beläge HR	Scheibe VR	Scheibe HR	Jahr	Kupplung	Glocke
X-LARGE									
	125 cc	2002>2003	FD.0256	FD.0256	*****	*****	*****	*****	*****
	150 cc	2002>2003	FD.0256	FD.0256	*****	*****	*****	*****	*****
	200 cc	2002>2003	FD.0256	FD.0256	*****	*****	*****	*****	*****
Derbi	CC	Jahr	Beläge VR	Beläge HR	Scheibe VR	Scheibe HR	Jahr	Kupplung	Glocke
Atlantis									
	50 cc	1999-2000	FD.0094	GF.1233	*****	()	*****	*****	*****
	50 cc H2O	2001>	FD.0094	*****	*****	*****	*****	*****	*****
	50 cc WAVE	2001>	FD.0094	*****	*****	*****	*****	*****	*****
	50 cc 4 T	2004>	FD.0094	*****	*****	*****	*****	*****	*****
	50 cc BULLET	2004>	FD.0094	*****	*****	*****	*****	*****	*****
	100 cc H2O	2001>	FD.0094	*****	*****	*****	*****	*****	*****
	100 cc 4 T	2004>	FD.0094	*****	*****	*****	*****	*****	*****
BLACK DEVIL									
	50 cc	2004>	FD.0195	FD.0094	*****	*****	*****	*****	*****
DRD RACING R + SM									
	50 cc	2005>	FD.0195	FD.0094	*****	*****	*****	*****	*****
GP 1									
	50 cc	2001>2004	FD.0142	FD.0142	*****	*****	*****	*****	*****
	50 cc EURO 2	2005>	FD.0380	FD.0094	*****	*****	*****	*****	*****
	125 cc	2005>	FD.0256	FD.0094	*****	*****	*****	*****	*****
	250 cc	2005>	FD.0256	FD.0298	*****	*****	*****	*****	*****
GPR									
	50 cc	1996	FD.0098	FD.0048	*****	*****	*****	*****	*****
	50 cc R	1997>	FD.0162	FD.0094	DF.4050	DF.4053	*****	*****	*****
	50 cc RACING + NUDE	2004>	FD.0380	FD.0094	*****	*****	*****	*****	*****
	75 cc SPORT	1990	FD.0098	FD.0048	*****	*****	*****	*****	*****
	80 cc CUP	2004	FD.0256	FD.0094	*****	*****	*****	*****	*****
	125 cc RACING + NUDE	2004>	FD.0380	FD.0094	*****	*****	*****	*****	*****
Hunter									
	50 cc	1995>	FD.0094	GF.1233	*****	()	1995>	FC.1336	G.0688
Paddock ST									
	50 cc	1996>	FD.0094	GF.1233	*****	()	*****	*****	*****
Predator LC									
	50 cc	1998>	FD.0142	FD.0142	*****	*****	*****	*****	*****
Predator 02									
	50 cc	1999>	FD.0142	GF.1233	*****	()	*****	*****	*****
SENDA									
	50 cc	1994>	FD.0094	GF.1277	*****	*****	*****	*****	*****
	50 cc R + X-TREME	1994>2004	FD.0094	FD.0094	*****	*****	*****	*****	*****
	50 cc L + SM	1999>	FD.0094	FD.0094	*****	*****	*****	*****	*****
	50 cc SM DRD BLACK EDITION	2003>	FD.0195	FD.0094	*****	*****	*****	*****	*****
	50 cc R DRD	2003>2004	FD.0162	FD.0094	*****	*****	*****	*****	*****
	50 cc SM DRD RACING	2003>2004	FD.0094	FD.0094	*****	*****	*****	*****	*****
	50 cc SM DRD RACING LTD	2005>	FD.0094	*****	*****	*****	*****	*****	*****
	125 cc X-TREME SM 4 T	2004>	FD.0195	FD.0094	*****	*****	*****	*****	*****
	125 cc R 4 T	2004	FD.0195	FD.0094	*****	*****	*****	*****	*****
Vamos									
	50 cc	1994>	FD.0142	GF.1233	*****	()	*****	*****	*****
	50 cc R	1995>	FD.0196	GF.1277	*****	()	*****	*****	*****
	50 cc R	1996>	FD.0142	GF.1277	*****	()	*****	*****	*****



Scooter-Beläge + Backen + Kupplung + Glocke Plaquette + mâchoire-Scooter

98

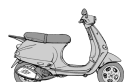

Derbi	CC	Jahr	Beläge VR	Beläge HR	Scheibe VR	Scheibe HR	Jahr	Kupplung	Glocke
Variant SPORT R									
	50 cc	1994 >	FD.0142	GF.1277	*****	()	*****	*****	*****
X-RACE R									
	50 cc	2005 >	FD.0094	FD.0094	*****	*****	*****	*****	*****
X-TREME R									
	50 cc	2005 >	FD.0094	FD.0094	*****	*****	*****	*****	*****
Ducati	CC	Jahr	Beläge VR	Beläge HR	Scheibe VR	Scheibe HR	Jahr	Kupplung	Glocke
748 Biposto									
	748 cc	1995 > 1998	FD.0093	FD.0012	*****	DF.5019	*****	*****	*****
748 Racing									
	748 cc CLIENTI	1995 > 1997	FD.0213	FD.0012	*****	*****	*****	*****	*****
	748 cc CLIENTI	1998 >	FD.0221	FD.0012	*****	*****	*****	*****	*****
748 S									
	748 cc	1999 > 2002	FD.0221	FD.0012	*****	*****	*****	*****	*****
748 SPS									
	748 cc	1998 > 1999	FD.0221	FD.0012	*****	DF.5014	*****	*****	*****
748 R									
	748 cc	2000 >	FD.0221	FD.0012	*****	DF.5019	*****	*****	*****
	748 cc	2001 > 2002	FD.0305	FD.0012	*****	DF.5019	*****	*****	*****
749 S									
	749 cc	2003 >	FD.0305	FD.0256	*****	*****	*****	*****	*****
749 R									
	749 cc	2004 >	FD.0305	FD.0256	*****	*****	*****	*****	*****
851 Superbike Biposto									
	851 cc	1988 >	FD.0093	FD.0012	*****	DF.5014	*****	*****	*****
907 I.E.									
	900 cc	1992 >	FD.0093	FD.0012	*****	DF.5014	*****	*****	*****
916 Biposto-Senna									
	916 cc	1994 >	FD.0221	FD.0012	*****	DF.5019	*****	*****	*****
916 Racing CLIENTI									
	916 cc	1995 >	FD.0213	FD.0012	*****	DF.5019	*****	*****	*****
916 STRADA + SUPERSPORT4									
	916 cc	1998 >	FD.0221	FD.0256	*****	DF.5019	*****	*****	*****
996 R / R II									
	996 cc	2001 >	FD.0221	FD.0012	*****	DF.5019	*****	*****	*****
996 SPS									
	996 cc	1998 >	FD.0221	FD.0256	*****	DF.5019	*****	*****	*****
Monster									
	400 cc	2001 >	FD.0221	FD.0012	*****	*****	*****	*****	*****
	600 cc	1993 > 1999	FD.0093	FD.0012	*****	DF.5014	*****	*****	*****
	600 cc	2000 >	FD.0221	FD.0012	*****	*****	*****	*****	*****
	620 cc S + IE	2002 >	FD.0221	FD.0012	*****	*****	*****	*****	*****
	750 cc	1996 > 1999	FD.0093	FD.0012	*****	DF.5014	*****	*****	*****
	750 cc	2000 > 2001	FD.0221	FD.0012	*****	*****	*****	*****	*****
	750 cc IE	2002 >	FD.0221	FD.0012	*****	*****	*****	*****	*****
	800 cc DARK IE	2003 >	FD.0221	FD.0012	*****	*****	*****	*****	*****
	800 cc S2R	2005 >	FD.0216	FD.0012	*****	*****	*****	*****	*****
	900 cc	1993 > 1999	FD.0093	FD.0012	*****	DF.5014	*****	*****	*****
	996 cc S4R	2004 >	FD.0221	FD.0012	*****	DF.5014	*****	*****	*****
	1000 cc MONSTER DARK IE	2003 >	FD.0221	FD.0012	*****	*****	*****	*****	*****
	1000 cc MONSTER IE	2003 >	FD.0221	FD.0012	*****	*****	*****	*****	*****



Scooter-Beläge + Backen + Kupplung + Glocke Plaquette + mâchoire-Scooter

98



Ducati	CC	Jahr	Beläge VR	Beläge HR	Scheibe VR	Scheibe HR	Jahr	Kupplung	Glocke
Sport									
	620 cc	2003 >	FD.0221	FD.0256	*****	*****	*****	*****	*****
	750 cc	2000 >	FD.0221	FD.0256	*****	DF.5014	*****	*****	*****
	800 cc	2003 >	FD.0221	FD.0256	*****	*****	*****	*****	*****
	900 cc	2002 >	FD.0221	FD.0256	*****	*****	*****	*****	*****
	1000 cc	2005 >	FD.0216	FD.0256	*****	*****	*****	*****	*****
Sport Touring 2									
	900 cc	1999 >	FD.0221	FD.0256	*****	*****	*****	*****	*****
Supersport									
	750 cc	1991 > 1997	FD.0093	FD.0012	*****	*****	*****	*****	*****
	750 cc	1998 >	FD.0221	FD.0256	*****	*****	*****	*****	*****
	800 cc	2003 >	FD.0221	FD.0256	*****	*****	*****	*****	*****
	900 cc	1998 >	FD.0221	FD.0256	*****	DF.5014	*****	*****	*****
	916 cc 4	1998 >	FD.0221	FD.0256	*****	*****	*****	*****	*****
	944 cc 2	1998 >	FD.0221	FD.0256	*****	*****	*****	*****	*****
	1000 cc DS	2003 >	FD.0221	FD.0256	*****	*****	*****	*****	*****
Gilera	CC	Jahr	Beläge VR	Beläge HR	Scheibe VR	Scheibe HR	Jahr	Kupplung	Glocke
Dakota									
	350 cc	1986 >	FD.0091	GF.0227	*****	()	*****	*****	*****
	500 cc	1987 >	FD.0091	*****	*****	()	*****	*****	*****
D N A									
	50 cc	2000 > 2002	****	*****	****	****	2000 > 2002	FC.1333	G.0685
	50 cc	2005 > 2007	FD.0330	****	****	****	2005 > 2007	FC.1333	G.0685
	50 cc GP EXPERIENCE	2003 > 2004	****	****	****	****	2003 > 2004	FC.1333	G.0685
	125 cc	2001	****	****	****	****	2001 >	FC.1362	G.0705
	180 cc	2001 >	FD.0195	FD.0196	*****	*****	2001 >	FC.1365	G.0705
ICE									
	50 cc	2002 >	FD.0196	*****	*****	*****	*****	*****	*****
Nexus									
	250 cc EURO 3	2006	FD.0330	*****	*****	*****	2006 > 2007	FC.1385	G.0715
	250 cc SP EURO 3	2006 > 2007	FD.0330	*****	*****	*****	2006 > 2007	FC.1385	G.0715
	500 cc	2003 >	FD.0186	FD.0256	DF.4071	DF.4055	2003 >	FC.1370	G.0708
	500 cc EURO 3	2006	FD.0186	FD.0256	*****	*****	2006 > 2007	FC.1377	G.0708
	500 cc SP EURO 3	2006	FD.0186	FD.0256	*****	*****	2006 > 2007	FC.1377	G.0708
Runner									
	50 cc	1997-2000	FD.0196	GF.0261	DF.4015	()	1998 >	FC.1333	G.0685
Runner FX/FXR									
	125 cc	2000 >	FD.0195	FD.0249	DF.4015	DF.4042	1997 >	FC.1347	G.0689
	180 cc	1999 >	FD.0195	FD.0249	DF.4015	DF.4042	1998 >	FC.1354	G.0689
Runner Purejet									
	50 cc	2002-2004	FD.0330	FD.0249	*****	*****	2002 > 2006	FC.1333	G.0685
Runner SR RACE									
	50 cc	2006 >	FD.0330	FD.0249	*****	*****	2006 >	FC.1333	G.0685
Runner SR SC									
	50 cc	2006 > 2007	FD.0330	FD.0249	*****	*****	2006 > 2007	FC.1333	G.0685
Runner VX									
	200 cc	2002 >	FD.0195	FD.0298	DF.4015	DF.4012	*****	*****	*****
Runner VX 4 T									
	125 cc	2005-2006	FD.0330	FD.0298	*****	*****	2001 >	FC.1362	G.0705
Runner VX 4 T Race									
	125 cc	2006	FD.0330	FD.0298	*****	*****	*****	*****	*****



Scooter-Beläge + Backen + Kupplung + Glocke Plaquette + mâchoire-Scooter

98



Gilera	CC	Jahr	Beläge VR	Beläge HR	Scheibe VR	Scheibe HR	Jahr	Kupplung	Glocke
Runner VX 4 T SC									
	125 cc	2006-2007	FD.0330	FD.0298	*****	*****	*****	*****	*****
Runner VXR									
	125 cc	2001 >	FD.0195	FD.0298	DF.4015	DF.4012	*****	*****	*****
	180 cc	2001 >	FD.0195	FD.0298	DF.4015	DF.4012	2001 >	FC.1365	G.0705
	200 cc	2002 >	FD.0195	FD.0298	*****	*****	2002 > 2004	FC.1386	G.0715
	200 cc 4 T	2005 > 2006	FD.0330	FD.0298	*****	*****	2005 > 2006	FC.1386	G.0715
	200 cc 4 T RACE	2006	FD.0330	FD.0298	*****	*****	2006	FC.1386	G.0715
Stalker									
	50 cc	1997 >	FD.0196	FD.0249	DF.4001	DF.4013	1994 >	FC.1333	G.0685
Strom									
	50 cc	1994 >	FD.0196	GF.0252	DF.4001	()	1994 >	FC.1333	G.0685
Typhoon									
	125 cc	1995 >	FD.0196	GF.0261	DF.4001	()	*****	*****	*****
Typhoon									
	50 cc	1993 > 1995	FD.0196	GF.0252	DF.4001	()	1993 >	FC.1333	G.0685
	50 cc	1996 >	FD.0196	GF.0263	DF.4001	()	*****	*****	*****
	50 cc CATALYZED	2002	FD.0196	FD.0196	DF.4001	*****	*****	*****	*****
Typhoon X-XR									
	125 cc	2000 >	FD.0196	GF.0261	DF.4001	()	*****	*****	*****
Honda									
	CC	Jahr	Beläge VR	Beläge HR	Scheibe VR	Scheibe HR	Jahr	Kupplung	Glocke
CNHelix / Spazio									
	250 cc	1986 > 1987	FD.0054	GF.1188	DF.4008	()	*****	*****	*****
Dylan									
	125 cc	2001 >	FD.0304	GF.1316	*****	()	*****	*****	*****
	150 cc	2001 >	FD.0304	GF.1316	*****	()	*****	*****	*****
Foresight									
	250 cc	1997 > 2000	FD.0253	GF.1307	DF.4034	()	1998 >	FC.1352	G.0697
	250 cc	2001 >	FD.0255	FD.0136	DF.4034	DF.4060	1998 >	FC.1352	G.0697
Jazz									
	250 cc	2001 >	FD.0253	FD.0324	DF.4034	*****	*****	*****	*****
Nes									
	125 cc	2000 >	FD.0304	GF.1316	DF.4059	()	2000 >	FC.1345	G.0699
	150 cc	2000 >	FD.0304	*****	DF.4059	*****	2000 >	FC.1345	G.0699
NH Lead									
	50 cc	1988 > 1992	FD.0166	GF.1198	*****	()	1988 > 1992	FC.1335	*****
	50 cc	1993 > 1994	GF.1043	GF.1198	()	()	1993 >	FC.1343	G.0686
	50 cc	1994 >	FD.0192	GF.1198	*****	()	1993 >	FC.1343	G.0686
Pantheon 2 T									
	125 cc	1998 > 2002	FD.0253	GF.1307	DF.4034	()	1998 >	FC.1359	G.0697
	150 cc	1998 > 2002	FD.0253	GF.1307	DF.4034	()	1998 >	FC.1359	G.0697
Pantheon 4 T									
	125 cc	2003 >	FD.0255	FD.0136	DF.4034	*****	1998 >	FC.1359	G.0697
	150 cc	2003 >	FD.0255	FD.0136	DF.4034	*****	1998 >	FC.1359	G.0697
PKL Wallaro									
	50 cc	1990 >	GF.1248	GF.1043	()	()	*****	*****	*****
Scoopy SH 75									
	75 cc	1988 >	GF.1043	GF.1229	()	()	*****	*****	*****
SFX S / SV									
	50 cc	1995 >	FD.0196	GF.1043	DF.4006	()	1995 >	FC.1330	G.0686
SH									
	125 + 150cc	2000 >	FD.0304	GF.1316	DF.4059	()	2000 >	FC.1345	G.0699



Scooter-Beläge + Backen + Kupplung + Glocke Plaquette + mâchoire-Scooter

98

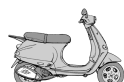

Honda	CC	Jahr	Beläge VR	Beläge HR	Scheibe VR	Scheibe HR	Jahr	Kupplung	Glocke	
SH H										
	50 cc	CITY EXPRESS	1994>	GF.1043	GF.1229	()	()	1990>	FC.1335	*****
	50 cc	SCOOPY	1988>1994	GF.1229	GF.1229	()	()	1990>	FC.1335	*****
	50 cc	FIFTY	1997>	FD.0196	GF.1043	DF.4020	()	1990>	FC.1335	*****
Sj Bali										
	50 cc		1993>	FD.0238	GF.1043	DF.4001	()	1993>	FC.1330	G.0686
SRX Shadow										
	50 cc		1998>	*****	GF.1043	*****	()	1998>	FC.1335	*****
SXR W										
	50 cc		1997>	FD.0196	*****	*****	*****	*****	*****	*****
Yuppy NH90										
	90 cc		1990>	FD.0192	GF.1178	DF.4001	()	*****	*****	*****
Italjet										
	CC		Jahr	Beläge VR	Beläge HR	Scheibe VR	Scheibe HR	Jahr	Kupplung	Glocke
Bazooka 1										
	50 cc		1991	GF.0256	GF.0253	()	()	1991>	FC.1331	G.0683
Bazooka 2										
	50 cc		1992>	FD.0175	GF.0253	DF.4004	()	1991>	FC.1331	G.0683
Formula Air / LC										
	50 cc		1994>1996	FD.0194	FD.0196	DF.4028	*****	1994>	FC.1334	*****
	50 cc		1997>	FD.0094	FD.0094	DF.4028	*****	1994>	FC.1334	*****
Jetset										
	125 cc		2002>	FD.0323	*****	*****	()	*****	*****	*****
	150 cc		2002>	FD.0323	*****	*****	()	*****	*****	*****
Jupiter										
	125 cc		2002>	FD.0205	FD.0323	*****	*****	*****	*****	*****
	150 cc		2002>	FD.0205	FD.0323	*****	*****	*****	*****	*****
Millennium										
	125 cc		>2000	FD.0124	*****	*****	()	*****	*****	*****
	125 cc		2001>	FD.0323	FD.0334	*****	*****	*****	*****	*****
	150 cc		>2000	FD.0124	*****	*****	()	*****	*****	*****
	150 cc		2001>	FD.0323	FD.0334	*****	*****	2001>	FC.1361	G.0698
Pista 2 Yankee										
	50 cc		1990>	GF.0256	GF.0253	()	()	1992>	FC.1331	G.0683
Reporter										
	50 cc		1990>	GF.0256	GF.0253	()	()	1990>	FC.1331	G.0683
Scoop 2/3										
	50 cc		1993>	FD.0175	GF.0253	DF.4004	()	1993>	FC.1331	G.0683
Torpedo										
	125 cc		1999>	FD.0094	*****	*****	()	*****	*****	*****
	150 cc		2001>	FD.0094	*****	*****	()	*****	*****	*****
Torpedo 2 T										
	50 cc		1997>	FD.0094	GF.1233	*****	*****	1997>	FC.1334	*****
Velocifero										
	50 cc		1994>	GF.1289	GF.1233	()	()	1994>	FC.1334	*****
Kymco										
			Jahr	Beläge VR	Beläge HR	Scheibe VR	Scheibe HR	Jahr	Kupplung	Glocke
Agility										
	50 cc		2005>	FD.0257	*****	*****	*****	*****	*****	*****
B&W										
	50 cc		2004>	FD.0257	*****	*****	*****	*****	*****	*****
	125 cc		2000>	FD.0257	FD.0257	*****	*****	*****	*****	*****
	150 cc		2000>	FD.0257	FD.0257	*****	*****	*****	*****	*****
	250 cc		2000>	FD.0257	FD.0257	DF.4064	*****	*****	*****	*****



Scooter-Beläge + Backen + Kupplung + Glocke Plaquette + mâchoire-Scooter

98



Kymco	Jahr	Beläge VR	Beläge HR	Scheibe VR	Scheibe HR	Jahr	Kupplung	Glocke
CX								
50 cc	1993	GF.1043	GF.1248	()	()	*****	*****	*****
CX Super								
50 cc	1994-1997	FD.0192	GF.1248	DF.4006	()	1994>	FC.1330	G.0686
Dink								
50 cc	1997>	FD.0257	GF.1043	DF.4025	()	*****	*****	*****
125 cc	1996>1999	FD.0257	FD.0257	DF.4025	DF.4025	1997>	FC.1356	G.0700
150 cc	1997>	FD.0257	FD.0257	DF.4025	DF.4025	1997>	FC.1356	G.0700
200 cc	2004>	FD.0257	FD.0257	*****	*****	*****	*****	*****
Dink Classic Euro 2								
50 cc	2003	FD.0257	GF.1043	()	*****	*****	*****	*****
125 cc	2002>	FD.0257	FD.0257	DF.4064	DF.4025	*****	*****	*****
150 cc	2002>	FD.0257	FD.0257	DF.4064	*****	*****	*****	*****
Dink LX								
125 cc	1998>2000	FD.0257	FD.0257	DF.4025	DF.4025	*****	*****	*****
150 cc	1998>2000	FD.0257	FD.0257	DF.4025	DF.4025	*****	*****	*****
DJ W								
50 cc	1994>	GF.1043	GF.1248	()	()	1994>	FC.1330	G.0686
DJ X								
50 cc	1992>	GF.1043	GF.1248	()	()	1992>	FC.1330	G.0686
DJ Y								
50 cc	1993>	GF.1043	GF.1248	()	()	1993>	FC.1330	G.0686
Filly								
50 cc	1998>	GF.1043	GF.1043	()	()	*****	*****	*****
Filly LX								
50 cc	2002>	FD.0230	GF.1043	*****	()	*****	*****	*****
Gran Dink								
250 cc	2001>	FD.0327	FD.0328	DF.4064	DF.4065	2001>	FC.1372	G.0711
Gran Dink								
125 cc	2002>	FD.0257	FD.0257	DF.4064	*****	*****	*****	*****
150 cc	2002>	FD.0257	FD.0257	DF.4064	*****	*****	*****	*****
Heroism								
125 cc	1995>	FD.0223	GF.1043	DF.4006	()	1995>1997	FC.1345	G.0699
150 cc	1995>	FD.0223	FD.0224	DF.4006	DF.4016	1995>1997	FC.1345	G.0699
Heroism VERSINE ALLEGERITA								
125 cc	1995>	FD.0223	GF.1043	DF.4006	()	1995>1997	FC.1355R	G.0699
150 cc	1995>	FD.0223	FD.0224	DF.4006	DF.4016	1995>1997	FC.1355R	G.0699
KXR								
250 cc	2003>2004	FD.0383	FD.0392	*****	*****	*****	*****	*****
Movie								
125 cc	1999>	FD.0257	GF.1310	*****	()	1999>2000	FC.1345	G.0699
Movie XL								
125 cc	2001>	FD.0257	*****	DF.4064	*****	2001>	FC.1345	G.0699
150 cc	2001>	FD.0257	*****	DF.4064	*****	2001>	FC.1345	G.0699
250 cc	2005>	FD.0383	FD.0327	****	****	****	****	****
People								
50 cc	1999>	FD.0269	GF.1310	DF.4036	()	*****	*****	*****
125 cc	1999>	FD.0269	GF.1310	DF.4036	*****	1999>2003	FC.1345	G.0699
150 cc	1999>	FD.0269	GF.1310	DF.4036	*****	1999>2003	FC.1345	G.0699
250 cc	2003>	FD.0257	FD.0373	*****	*****	2003>	FC.1372	G.0711
People S								
125 cc	2005>	FD.0269	GF.1310	DF.4080	****	****	****	****



Scooter-Beläge + Backen + Kupplung + Glocke Plaquette + mâchoire-Scooter

98

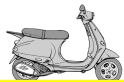

Kymco	Jahr	Beläge VR	Beläge NR	Scheibe VR	Scheibe HR	Jahr	Kupplung	Glocke
People S								
200 cc	2005>	FD.0269	GF.1310	DF.4080	****	****	****	****
250 cc	2006	FD.0208	****	DF.4080	DF.4080	2006>	FC.1372	G.0711
Super 9								
50 cc	2000-2001	FD.0114	*****	DF.4025	*****	*****	*****	*****
Super 9 Sport Euro 2								
50 cc	2002>	FD.0257	FD.0269	DF.4025	*****	*****	*****	*****
Top Boy								
50 cc	1996>	FD.0257	GF.1043	DF.4025	()	*****	*****	*****
Vitality 2 T + 4 T								
50 cc	2004>	FD.0230	*****	*****	*****	*****	*****	*****
Vivio								
125 cc	2001>	FD.0230	*****	*****	*****	2000>	FC.1345	G.0699
150 cc	2001>	FD.0230	*****	*****	*****	2000>	FC.1345	G.0699
X-Citing								
250 cc	2004>	FD.0132	FD.0132	*****	*****	*****	*****	*****
500 cc	2004>	FD.0132	FD.0132	*****	*****	*****	*****	*****
YUP								
50 CC	2001>2002	FD.0192	GF.1043	*****	()	*****	*****	*****
250 CC	2003>	FD.0257	FD.0257	*****	*****	2003>	FC.1372	G.0711
YUP Euro 2								
50 CC	2002>	FD.0230	*****	*****	*****	*****	*****	*****
Malaguti								
Centro Base								
50 cc	>1992	GF.0153	GF.0255	()	()	1992>	FC.1331	G.0683
Centro SL								
50 cc	1993>	FD.0098	GF.0255	DF.4002	()	1998>	FC.1349	G.0684
Centro SL Kat								
50 cc	1993>	FD.0098	GF.0255	DF.4002	()	1998>	FC.1349	G.0684
Ciak								
50 cc	1999>	FD.0196	GF.0255	DF.4030	()	*****	*****	*****
100 cc	1999>2001	FD.0196	FD.0196	DF.4030	*****	*****	*****	*****
125 cc	2001>	FD.0263	GF.1184	DF.4030	()	2001>	FC.1345	G.0699
150 cc	2001>	FD.0263	GF.1184	DF.4030	()	2001>	FC.1345	G.0699
Ciak 100 F12								
100 cc	1999>2001	FD.0196	FD.0196	DF.4030	*****	*****	*****	*****
Ciak Master								
50 cc	2004>2005	FD.0196	GF.0255	****	()	*****	*****	*****
50 cc 4 T	2005>2006	FD.0196	GF.0268	DF.4030	()	****	****	****
50 cc EURO 2	2006>	FD.0196	GF.0255	DF.4030	()	****	****	****
Ciak TWIN DISK								
50 cc	2002>	FD.0196	FD.0196	****	****	*****	*****	*****
Crosser CRI								
50 cc	1995>	FD.0074	GF.0264	DF.4001	()	1995>	FC.1334	*****
Crosser CRI								
50 cc	1997>	FD.0196	GF.0264	DF.4001	()	1995>	FC.1334	*****
F 10 Kat								
50 cc	1994>	FD.0196	GF.0255	DF.4009	()	1997>	FC.1349	G.0684
F 10 Restyling								
50 cc	2002>	FD.0196	GF.0255	DF.4009	()	1997>	FC.1349	G.0684
F 10 Restyling Euro 2-2.3								
50 cc	2002>	FD.0196	GF.0255	DF.4009	()	1997>	FC.1349	G.0684



Scooter-Beläge + Backen + Kupplung + Glocke Plaquette + mâchoire-Scooter

98



Malaguti	Jahr	Beläge VR	Beläge HR	Scheibe VR	Scheibe HR	Jahr	Kupplung	Glocke
F 10 Restyling Euro 2 2006								
50 cc	2006	****	****	DF.4009	****	1997>	FC.1349	G.0684
F 10 Restyling Euro 2								
50 cc	2002>	FD.0196	GF.0255	DF.4009	()	1997>	FC.1349	G.0684
F 12 R Aria								
50 cc	2007-2008	****	****	DF.4033	DF.4001	*****	*****	*****
F 12 Phantom LC								
50 cc	1994>1997	FD.0074	GF.0255	DF.4001	()	1994>1996	FC.1331	G.0683
F 12 Phantom								
50 cc	1994>1997	FD.0074	GF.0255	DF.4001	()	1994>1996	FC.1331	G.0683
100 cc	1998>	FD.0098	FD.0196	DF.4001	DF.4001	*****	*****	*****
F 12 Phantom Euro 1								
50 cc	1998>	FD.0098	FD.0196	DF.4001	DF.4001	1997>	FC.1349	G.0684
F 12 Phantom LC Euro 1								
50 cc	1998>	FD.0098	FD.0196	DF.4001	DF.4001	1997>	FC.1349	G.0684
F 12 Phantom LC Restyling Euro 2								
50 cc	1998>	FD.0098	FD.0196	DF.4001	DF.4001	1997>	FC.1349	G.0684
F 12 Phantom LC Restyling Euro 2-2.3								
50 cc	1998>	FD.0098	FD.0196	DF.4001	DF.4001	1997>	FC.1349	G.0684
F 12 Phantom LC Twin Disk								
50 cc	1998>	FD.0098	FD.0196	DF.4001	DF.4001	1997>	FC.1349	G.0684
F 12 Phantom Restyling								
50 cc	2001>2002	FD.0196	FD.0196	DF.4033	DF.4001	1997>	FC.1349	G.0684
F 12 Phantom Restyling Euro 2								
50 cc	2002>	FD.0196	FD.0196	DF.4033	DF.4001	1997>	FC.1349	G.0684
F 12 Phantom Restyling Euro 2-2.3								
50 cc	2003-2004	FD.0196	FD.0196	DF.4033	DF.4001	1997>	FC.1349	G.0684
F 15 Fire Fox								
50 cc	1996>1997	FD.0098	GF.0255	DF.4012	()	1996>1997	FC.1331	G.0683
F 15 Fire Fox								
50 cc	1998>	FD.0098	FD.0196	DF.4012	DF.4001	1997>1998	FC.1349	G.0684
F 15 Fire Fox Euro 2								
50 cc	2002>2003	FD.0098	FD.0196	DF.4033	DF.4001	1998>	FC.1349	G.0684
F 15 Fire Fox Restyling Euro 2-2.3								
50 cc	2003>2004	FD.0098	FD.0196	DF.4033	DF.4001	1998>	FC.1349	G.0684
F 15 Fire Fox Twin Disk & Special								
50 cc	1998>1999	FD.0098	FD.0196	DF.4012	DF.4001	1998>	FC.1349	G.0684
F 15 Fire Fox Twin Disks Digit Kat								
50 cc	1999>	FD.0098	FD.0196	DF.4033	DF.4001	1998>	FC.1349	G.0684
F 15 LC-TDS Restyling Euro 1								
50 cc	2001>	FD.0098	FD.0196	DF.4033	DF.4001	1998>	FC.1349	G.0684
F 18 Warrior								
125 cc	2001>	FD.0263	FD.0267	DF.4058	DF.4033	2001>	FC.1349	G.0700
150 cc	2001>	FD.0263	FD.0267	DF.4058	DF.4033	2001>	FC.1356	G.0700
Grizzly 4 Wheels								
50 cc	1987>	GF.0210	GF.0210	()	()	*****	*****	*****
Madison 3								
125 cc	2006>2009	FD.0281	FD.0356	DF.4031	DF.4032	1999>	FC.1360	G.0704
250 cc	2006>2009	FD.0281	FD.0356	DF.4029	DF.4032	1999>	FC.1351	G.0698
Madison K								
400 cc	2002>	FD.0282	FD.0267	DF.4061	DF.4029	2002>	FC.1357	G.0701



Scooter-Beläge + Backen + Kupplung + Glocke Plaquette + mâchoire-Scooter

98



Malaguti	Jahr	Beläge VR	Beläge HR	Scheibe VR	Scheibe HR	Jahr	Kupplung	Glocke
Madison K RST								
400 cc	2003>	FD.0282	FD.0267	DF.4061	DF.4029	2002>	FC.1357	G.0701
Madison R								
180 cc	2001>	FD.0281	FD.0267	DF.4031	DF.4032	2001>	FC.1365	G.0705
Madison R Restyling Euro 2								
125 cc	2003>2004	FD.0281	FD.0267	DF.4031	DF.4032	1999>	FC.1360	G.0704
Madison RS Restyling								
250 cc	2004>	FD.0281	FD.0267	DF.4029	DF.4032	1999>	FC.1351	G.0698
Madison S								
250 cc	1999>	FD.0281	FD.0267	DF.4029	DF.4032	1999>	FC.1351	G.0698
Madison S Restyling								
200 cc	2002>	FD.0281	FD.0267	DF.4031	DF.4032	*****	*****	*****
Madison S Restyling Euro 2								
200 cc	2003>	FD.0281	FD.0267	DF.4031	DF.4032	*****	*****	*****
Password + EU3								
250 cc	2005>	FD.0281	FD.0267	DF.4090	DF.4090	*****	*****	*****
Phantom Max								
125 cc	2003>	FD.0281	FD.0267	DF.4031	DF.4032	*****	*****	*****
200 cc	2003>	FD.0281	FD.0267	DF.4031	DF.4032	*****	*****	*****
250 cc	2004>	FD.0281	FD.0267	DF.4031	DF.4032	*****	*****	*****
Spider Max								
500 cc	2004>2005	FD.0091	FD.0357	****	****	*****	*****	*****
Spider Max GT 500								
500 cc	2006>	FD.0091	FD.0357	****	****	*****	*****	*****
MBK								
Jahr	Beläge VR	Beläge HR	Scheibe VR	Scheibe HR	Jahr	Kupplung	Glocke	
Booster / Road / Spirit / Track								
50 cc	1994>	FD.0197	GF.1187	DF.4004	()	1994>	FC.1331	G.0683
Booster / Next Generation / Track								
50 cc	1996>	FD.0197	GF.1200	DF.4021	()	1996>	FC.1331	G.0683
50 cc	1997>	FD.0197	GF.1200	DF.4021	()	1997>	FC.1349	G.0684
CT S Sorriso								
50 cc	1992>	GF.1200	GF.1200	()	()	****	****	****
Evolis								
50 cc	1992>	FD.0197	GF.1200	DF.4004	()	1992>	FC.1336	G.0688
Fizz								
50 cc	1994>	FD.0197	GF.1187	DF.4004	()	1994>	FC.1336	G.0688
Flipper								
50 cc	1998>	FD.0196	GF.1187	*****	()	****	****	****
Forte								
50 cc	1994>	FD.0197	GF.1187	DF.4004	()	1994>	FC.1336	G.0688
Mach								
50 cc	2002>	FD.0197	****	****	()	****	****	****
Nitro								
50 cc	1997>	FD.0197	FD.0251	DF.4066	DF.4066	1997>	FC.1349	G.0684
Ovetto								
50 cc	1997>	FD.0197	GF.1200	*****	()	1997>	FC.1349	G.0684
Rocket								
50 cc	1996>	FD.0196	GF.1200	DF.4021	()	1996>	FC.1331	G.0683
Stunt								
50 cc	2000>	FD.0196	GF.1200	DF.4066	()	****	****	****
X Limit								
50 cc	1998>2003	FD.0098	GF.1200	****	()	****	****	****



Scooter-Beläge + Backen + Kupplung + Glocke Plaquette + mâchoire-Scooter

98

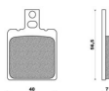

MBK	Jahr	Beläge VR	Beläge HR	Scheibe VR	Scheibe HR	Jahr	Kupplung	Glocke
X Limit								
50 cc	2004 >	FD.0094	FD.0094	****	****	****	****	****
X Power								
50 cc	2004 >	FD.0195	FD.0094	****	****	****	****	****
XN Doodo								
125 cc	2000 > 2001	FD.0197	GF.1303	****	()	2000 >	FC.1360	G.0704
150 cc	2001 >	FD.0197	GF.1303	****	()	2001 >	FC.1361	G.0698
XQ Thunder								
125 cc	2001 >	FD.0186	FD.0256	****	****	2001 >	FC.1360	G.0704
150 cc	2001 >	FD.0186	FD.0256	****	****	2001 >	FC.1361	G.0698
YP Skyliner								
125 cc	1998 > 2001	FD.0186	GF.1303	DF.4026	()	1998 >	FC.1360	G.0704
150 cc	1998 > 2001	FD.0186	GF.1303	DF.4026	()	2000 >	FC.1361	G.0698
150 cc	2002 >	FD.0186	FD.0256	DF.4026	DF.4067	2002 >	FC.1361	G.0698
180 cc	2000 >	FD.0205	FD.0259	****	****	2003 >	****	G.0698
250 cc	> 2000	FD.0205	FD.0259	DF.4023	DF.4045	> 2000	FC.1351	G.0698
250 cc	2000 >	FD.0205	FD.0259	DF.4023	DF.4045	2001 >	FC.1367	G.0709
400 cc	2004 >	FD.0205	FD.0259	****	****	****	****	****
Peugeot								
103 / 104 / 105 MVL								
50 cc		GF.1143	GF.1143	()	()	****	****	****
Vivacity								
50 cc	1998 >	FD.0165	GF.1043	DF.4001	()	****	****	****
Vivacity Kat								
50 cc	1998 >	FD.0094	GF.1043	****	()	****	****	****
Vivacity serie speciali								
50 cc	2005 >	FD.0061	****	****	****	****	****	****
X-Figth								
50 cc	2000 >	FD.0094	FD.0094	****	****	****	****	****
50 cc m	2000 >	FD.0094	GF.1043	****	()	****	****	****
X-Race								
50 cc	2002 >	FD.0162	FD.0094	****	****	****	****	****
Zenith L								
50 cc	1994 > 1995	FD.0178	GF.1043	DF.4009	()	1994 >	FC.1330	G.0686
Zenith LN/LS/N								
50 cc	1996 >	FD.0094	GF.1043	DF.4009	()	1994 >	FC.1330	G.0686
Buxy								
50 cc	1994 >	FD.0196	GF.1043	DF.4001	()	1994 >	FC.1330	G.0686
RS 50 cc	1994 >	FD.0085	GF.1043	DF.4001	()	1994 >	FC.1330	G.0686
Elyseo								
50 cc	1998 >	FD.0094	GF.1043	DF.4001	()	****	****	****
125 cc	1998 > 1999	FD.0094	GF.1289	DF.4044	()	****	****	****
125 cc	2000 >	FD.0195	FD.0323	DF.4044	****	1999 >	FC.1364	G.0707
150 cc	1999 > 2000	FD.0094	GF.1314	****	()	****	****	****
150 cc	2001 >	FD.0195	FD.0323	****	****	****	****	****
Elystar								
125 cc	2002 >	FD.0195	FD.0323	****	****	****	****	****
150 cc	2002 >	FD.0195	FD.0323	****	****	****	****	****
Elystar TSDI								
50 cc	2003 > 2005	FD.0094	FD.0323	****	****	****	****	****
GEOPOLIS								
250 cc	2006 >	FD.0330	FD.0323	****	****	****	****	****



Scooter-Beläge + Backen + Kupplung + Glocke Plaquette + mâchoire-Scooter

98

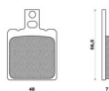

Peugeot	Jahr	Beläge VR	Beläge HR	Scheibe VR	Scheibe HR	Jahr	Kupplung	Glocke
GEOPOLIS								
400 cc	2006 >	FD.0132	FD.0330	****	****	****	****	****
Jet Force								
50 cc	2003 >	FD.0094	FD.0094	****	****	****	****	****
125 cc	2003 > 2004	FD.0195	FD.0323	****	****	****	****	****
Looxor								
50 cc	2001 >	FD.0094	GF.1043	****	()	****	****	****
100 cc	2002 >	FD.0094	FD.0094	****	****	****	****	****
125 cc	2003 >	FD.0253	FD.0094	****	****	****	****	****
150 cc	2003 >	FD.0282	****	****	****	****	****	****
Ludix								
50 cc	2004	FD.0094	GF.1043	****	()	****	****	****
Ludix								
50 cc	2004	GF.1043	GF.1043	()	()	****	****	****
Satelis								
250 cc	2004 >	FD.0094	FD.0323	****	****	****	****	****
250 cc ABS	2004 >	FD.0132	FD.0323	****	****	****	****	****
250 cc	2006 >	FD.0195	FD.0094	****	****	****	****	****
600 cc ABS	2004 >	FD.0132	FD.0323	****	****	****	****	****
SC Metropolis								
50 cc	1991 >	GF.1043	GF.1198	()	()	1991 >	FC.1335	****
Speedake								
50 cc	1995 >	FD.0196	GF.1043	DF.4001	()	1995 >	FC.1330	G.0686
Speedfight Aria Catalitico								
50 cc	1997 >	FD.0085	GF.1043	DF.4043	()	1995 >	FC.1330	G.0686
50 cc	1997 > 1998	FD.0094	GF.1043	DF.4043	()	1995 >	FC.1330	G.0686
Speedfight Aria/H2O								
50 cc	1998 >	FD.0094	FD.0094	DF.4043	DF.4043	1995 >	FC.1330	G.0686
ST								
50 cc	1985 > 1993	GF.1093	GF.1198	()	()	1985 >	FC.1330	G.0686
50 cc RAPIDO	1985 > 1993	GF.1246	GF.1246	()	()	1985 >	FC.1330	G.0686
SV Geo								
50 cc	1992 >	FD.0178	GF.1043	DF.4001	()	1992 >	FC.1330	G.0686
125 cc	1991 > 1992	FD.0178	GF.1043	DF.4001	()	****	****	****
125 cc	1993 >	FD.0192	GF.1043	DF.4001	()	****	****	****
Piaggio								
Beverli	Jahr	Beläge VR	Beläge HR	Scheibe VR	Scheibe HR	Jahr	Kupplung	Glocke
125 cc Heng Tong	2001 >	FD.0330	FD.0330	DF.4056	DF.4056	2001 >	FC.1362	G.0705
125 cc Grimeca	2001 >	FD.0195	FD.0195	DF.4056	DF.4056	2001 >	FC.1362	G.0705
125 cc RST	2005 >	FD.0330	FD.0330	DF.4056	DF.4056	2004 >	FC.1378	G.0715
200 cc Heng Tong	2001 >	FD.0330	FD.0330	DF.4056	DF.4056	2001 >	FC.1368	G.0705
200 cc Grimeca	2001 >	FD.0195	FD.0195	DF.4056	DF.4056	2001 >	FC.1368	G.0705
250 cc Leader	2004 >	FD.0330	FD.0330	DF.4056	DF.4056	2004 >	FC.1368	G.0715
250 cc RST	2005 >	FD.0330	FD.0330	DF.4056	DF.4056	2005 >	FC.1385	G.0715
250 cc Euro 3	2006 >	FD.0330	FD.0330	DF.4056	DF.4056	2006 >	FC.1385	G.0715
250 cc Sport	2006 >	FD.0330	FD.0330	DF.4056	DF.4056	2006 >	FC.1385	G.0715
250 cc Cruiser	2007 >	FD.0330	FD.0330	DF.4056	DF.4056	2007 >	FC.1385	G.0715
400 cc Euro 3	2006 >	FD.0186	FD.0330	DF.4071	DF.4055	2006 >	FC.1377	G.0708
500 cc	2003 >	FD.0256	FD.0256	DF.4056	DF.4055	2002 >	FC.1370	G.0708
500 cc Heng Tong	2005 >	FD.0256	FD.0394	DF.4056	DF.4055	2005 >	FC.1377	G.0708
500 cc Euro 3	2006 >	FD.0256	FD.0394	DF.4056	DF.4055	2006 >	FC.1377	G.0708



Scooter-Beläge + Backen + Kupplung + Glocke Plaquette + mâchoire-Scooter

98

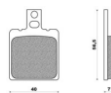

Piaggio	Jahr	Beläge VR	Beläge HR	Scheibe VR	Scheibe HR	Jahr	Kupplung	Glocke
COSA								
125 cc	1989 >	GF.0250	GF.0249	()	()	****	****	****
125 cc 2	1992 >	GF.0250	GF.0249	()	()	****	****	****
150 cc	1989 >	GF.0250	GF.0249	()	()	****	****	****
150 cc 2	1992 >	GF.0250	GF.0249	()	()	****	****	****
200 cc	1989 >	GF.0250	GF.0249	()	()	****	****	****
200 cc 2	1992 >	GF.0250	GF.0249	()	()	****	****	****
D N A								
50 cc	2000 > 2004	FD.0195	FD.0298	****	DF.4012	2000 >	FC.1333	G.0685
125 cc	2000 >	FD.0195	FD.0298	****	****	2000 >	FC.1362	G.0705
Fly								
50 cc 2T	2005 >	FD.0330	GF.0268	DF.4012	()	2005 >	FC.1333	G.0685
50 cc 4T	2005 >	FD.0330	GF.0268	DF.4012	()	2005 >	FC.1333	G.0685
125 cc	2005 >	FD.0330	GF.0268	DF.4012	()	2005 >	FC.1362	G.0715
150 cc	2005 >	FD.0330	GF.0268	DF.4012	()	2005 >	FC.1362	G.0715
Free								
50 cc	1993 > 1995	GF.0151	GF.0257	()	()	1993 >	FC.1333	G.0685
Free FL								
50 cc	1996 >	GF.0257	GF.0252	()	()	1996 >	FC.1333	G.0685
50 cc + PTT	1996 >	FD.0098	GF.0263	DF.4012	()	1996 >	FC.1333	G.0685
Hexagon								
125 cc	1994 >	FD.0196	GF.0261	DF.4005	()	1994 >	FC.1347	G.0689
125 cc	1994 >	FD.0196	GF.0261	DF.4005	()	1998 > 1999	FC.1350	G.0689
125 cc LX	2000 >	FD.0195	GF.0268	****	()	1998 >	FC.1347	G.0689
125 cc GTX 4T	2000 >	FD.0195	GF.0268	****	()	2000 >	FC.1378	G.0715
150 cc	1994 > 1997	FD.0196	GF.0261	DF.4005	()	1994 >	FC.1347	G.0689
150 cc	1998 > 1999	FD.0196	GF.0261	DF.4012	()	1994 >	FC.1347	G.0689
180 cc LX	1998 >	FD.0195	GF.0268	DF.4012	()	1998 >	FC.1354	G.0689
180 cc GTX 4T	1998 >	FD.0195	GF.0268	DF.4012	()	1998 >	FC.1365	G.0705
250 cc	1998 >	FD.0195	GF.1289	DF.4012	()	1998 >	FC.1346	G.0703
Liberty								
50 cc	1997 >	FD.0249	GF.0268	DF.4014	()	1997 >	FC.1333	G.0685
50 cc 4T	2000 >	FD.0249	GF.0268	DF.4014	()	1997 >	FC.1333	G.0685
125 cc 4T + PTT	1998 >	FD.0249	GF.0268	DF.4014	()	1998 > 2000	FC.1350	G.0690
125 cc 4T	1998 >	FD.0249	GF.0268	DF.4014	()	2000 >	FC.1362	G.0705
150 cc	2000 >	FD.0249	GF.0268	DF.4014	()	2000 >	FC.1362	G.0705
200 cc 4T + Sport	2006 >	FD.0249	GF.0268	DF.4014	()	2006 >	FC.1365	G.0715
MP 3								
125 cc Mano	2006 > 2008	FD.0439	****	****	****	2007 >	FC.1378	G.0715
125 cc	2006 > 2008	FD.0249	FD.0394	DF.4098	DF.4055	2007 >	FC.1378	G.0715
250 cc Mano	2006 > 2008	FD.0439	****	****	****	2006 > -2007	FC.1385	G.0715
250 cc	2006 > 2008	FD.0249	FD.0394	DF.4098	DF.4055	2006 > -2007	FC.1385	G.0715
250 cc Mic Mano	2008 > 2009	FD.0439	****	****	****	****	****	****
250 cc Mic	2008 > 2009	FD.0249	FD.0365	****	****	****	****	****
400 cc Mano	2007 > 2008	FD.0439	****	****	****	****	****	****
400 cc	2007 > 2008	FD.0249	FD.0330	****	****	****	****	****
400 cc Mic Mano	2008 > 2009	FD.0439	****	****	****	****	****	****
400 cc Mic	2008 > 2009	FD.0249	FD.0330	****	****	****	****	****
NRG								
50 cc	1994 > 1995	FD.0196	GF.0252	DF.4001	()	1994 >	FC.1333	G.0685
50 cc	1996 >	FD.0196	GF.0263	DF.4001	()	1996 >	FC.1333	G.0685



Scooter-Beläge + Backen + Kupplung + Glocke Plaquette + mâchoire-Scooter

98



Piaggio	Jahr	Beläge VR	Beläge HR	Scheibe VR	Scheibe HR	Jahr	Kupplung	Glocke
NRG MC2								
50 cc	1996>	FD.0196	GF.0263	DF.4001	()	1996>	FC.1333	G.0685
50 cc DD	1998>	FD.0196	FD.0249	DF.4001	DF.4013	1998>	FC.1333	G.0685
NRG MC3								
50 cc	2005>	FD.0196	FD.0249	****	****	2005>	FC.1333	G.0685
NRG Power DD								
50 cc	2004>2005	FD.0196	FD.0249	****	****	2004>	FC.1333	G.0685
NRG Purejet								
50 cc	2002>2004	FD.0196	FD.0249	****	****	2002>	FC.1333	G.0685
NTT								
50 cc	>1995	FD.0196	GF.0252	****	()	1994>	FC.1333	G.0685
50 cc	1996>	FD.0196	GF.0263	****	()	1994>	FC.1333	G.0685
Quartz								
50 cc	1992>	FD.0194	GF.0252	DF.4002	()	1992>	FC.1333	G.0685
Sfera								
50 cc	1991>1993	GF.0251	GF.0252	()	()	1991>	FC.1332	****
80 cc	1994>	GF.0251	GF.0252	()	()	****	****	****
125 cc	1995>	FD.0225	GF.0261	DF.4012	()	1995>	FC.1350	G.0690
125 cc	1994>	FD.0249	GF.0261	****	()	1995>	FC.1350	G.0690
Sfera RST.								
50 cc	1995>	FD.0225	GF.0263	DF.4012	()	1995>	FC.1333	G.0685
Skipper								
125 cc	1993>1997	FD.0194	GF.0261	DF.4002	()	1993>1999	FC.1347	G.0689
150 cc	1993>1997	FD.0194	GF.0261	DF.4002	()	1993>1999	FC.1347	G.0689
Skipper 4 T								
125 cc	1998>	FD.0195	GF.0268	DF.4015	()	2000>	FC.1362	G.0705
150 cc	1998>	FD.0195	GF.0268	DF.4015	()	2000>	FC.1362	G.0705
Super Hexagon GTX								
125 cc	>2000	FD.0195	FD.0249	DF.4012	DF.4012	>2000	FC.1362	G.0705
125 cc	2001>	FD.0330	FD.0298	DF.4055	DF.4014	****	****	****
180 cc	>2000	FD.0195	FD.0249	DF.4012	DF.4012	>2000	FC.1362	G.0705
180 cc	2001>	FD.0330	FD.0298	DF.4055	DF.4014	2001>	FC.1365	G.0705
250 cc	2000>	FD.0195	FD.0298	****	****	****	****	****
Velofax								
50 cc	1996>1999	GF.0261	GF.0265	()	()	1996>	FC.1333	G.0685
Vespa								
50 cc		GF.0162	GF.0130	()	()	****	****	****
50 cc Special		GF.0162	GF.0159	()	()	****	****	****
125 cc	1951>1962	GF.0162	GF.0087	()	()	****	****	****
125 cc	19963>1972	GF.0162	GF.0127	()	()	****	****	****
150 cc	1951>1962	GF.0162	GF.0087	()	()	****	****	****
150 cc	19963>1972	GF.0162	GF.0127	()	()	****	****	****
160 cc GS		GF.0024	GF.0128	()	()	****	****	****
180 cc SS		GF.0024	GF.0128	()	()	****	****	****
Vespa ET 2								
50 cc	1997-2001	FD.0249	GF.0261	DF.4012	()	1996>	FC.1333	G.0685
Vespa ET 3 + Primavera								
125 cc		GF.0162	GF.0159	()	()	****	****	****
Vespa ET 4								
50 cc	1999>	FD.0249	GF.0261	****	()	2000>	FC.1333	G.0685
125 cc	1996>	FD.0249	GF.0261	DF.4012	()	1996>	FC.1362	G.0705
125 cc	1996>	FD.0249	GF.0261	DF.4012	()	1999>2000	FC.1378	G.0715



Scooter-Beläge + Backen + Kupplung + Glocke Plaquette + mâchoire-Scooter

98

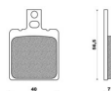

Piaggio	Jahr	Beläge VR	Beläge HR	Scheibe VR	Scheibe HR	Jahr	Kupplung	Glocke
Vespa ET 4								
150 cc	1996 >	FD.0249	GF.0261	****	()	1996 >	FC.1362	G.0705
Vespa FL 2 Automatica								
50 cc	1990 > 1991	GF.0128	GF.0128	()	()	****	****	****
125 cc V	1991 >	GF.0128	GF.0128	()	()	****	****	****
Vespa LX								
50 cc 4T	2005 >	FD.0249	GF.0261	DF.4012	()	2005 >	FC.1333	G.0685
50 cc 2T	2005 >	FD.0249	GF.0261	DF.4012	()	2005 >	FC.1333	G.0685
125 cc	2005 >	FD.0249	GF.0261	DF.4012	()	2003 >	FC.1362	G.0705
125 cc EURO 3 + V 4T	2005 >	FD.0249	GF.0261	DF.4012	()	2006 > 2007	FC.1378	G.0715
150 cc	2005 >	FD.0249	GF.0261	DF.4012	()	2005 > 2006	FC.1362	G.0715
150 cc	2005 >	FD.0249	GF.0261	DF.4012	()	2006 > 2007	FC.1378	G.0715
Vespa 250 GTS								
250 cc Heng Tong	2005 >	FD.0330	FD.0298	DF.4014	DF.4014	2005 >	FC.1385	G.0715
250 cc Grimeca	2005 >	FD.0195	FD.0298	DF.4014	DF.4014	2005 >	FC.1385	G.0715
Vespa 250 GTV								
250 cc	2006 >	FD.0330	FD.0298	DF.4014	DF.4014	2006 >	FC.1385	G.0715
Vespa PE								
200 cc	1998 >	GF.0128	GF.0128	()	()	****	****	****
Vespa PX								
125 cc	1978 >	GF.0128	GF.0128	()	()	****	****	****
125 cc Arcobalena	1983 >	GF.0128	GF.0128	()	()	****	****	****
150 cc	1978 >	GF.0128	GF.0128	()	()	****	****	****
150 cc Arcobalena	1983 >	GF.0128	GF.0128	()	()	****	****	****
150 cc	1998 >	FD.0266	GF.0128	DF.4012	()	****	****	****
200 cc E	1978 >	GF.0128	GF.0128	()	()	****	****	****
200 cc Arcobalena	1983 >	GF.0128	GF.0128	()	()	****	****	****
200 cc	1998 >	FD.0266	GF.0128	DF.4012	()	****	****	****
Vespa Granturismo L								
125 cc Grimeca	2003 >	FD.0195	FD.0298	****	****	2003 >	FC.1362	G.0705
125 cc Heng Tong	2003 >	FD.0330	FD.0298	****	****	2003 >	FC.1362	G.0705
200 cc Grimeca	2003 >	FD.0195	FD.0298	****	****	2003 >	FC.1371	G.0705
200 cc Heng Tong	2003 >	FD.0330	FD.0298	****	****	2003 >	FC.1371	G.0705
Vespa PK Automatica								
50 cc	1984 >	GF.0128	GF.0224	()	()	****	****	****
Vespa PK XL Plurimatic								
50 cc	1986 >	GF.0128	GF.0128	()	()	****	****	****
Vespa Rally								
200 cc		GF.0024	GF.0128	()	()	****	****	****
X								
125 cc EVO	2007 >	FD.0330	FD.0365	****	****	****	****	****
250 cc EVO	2007 >	FD.0330	FD.0365	****	****	****	****	****
X 7								
125 cc	2007 >	FD.0330	FD.0330	****	****	****	****	****
X 8								
125 cc	2004 >	FD.0330	FD.0256	DF.4071	DF.4055	2004 >	FC.1362	G.0705
125 cc Heng Tong	2005 >	FD.0330	FD.0394	DF.4071	DF.4055	2005 >	FC.1378	G.0715
125 cc Premium	2006 >	FD.0330	FD.0394	DF.4071	DF.4055	2006 >	FC.1378	G.0715
125 cc Street Euro 3	2006 >	FD.0330	GF.0268	DF.4071	()	2006 >	FC.1378	G.0715
150 cc Street Euro 3	2006 >	FD.0330	GF.0268	DF.4071	()	2006 >	FC.1378	G.0715
200 cc	2004 >	FD.0330	FD.0256	DF.4071	DF.4055	****	****	****
200 cc Heng Tong	2005 >	FD.0330	FD.0394	****	****	****	****	****



Scooter-Beläge + Backen + Kupplung + Glocke Plaquette + mâchoire-Scooter

98

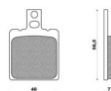

Piaggio								
	Jahr	Beläge VR	Beläge HR	Scheibe VR	Scheibe HR	Jahr	Kupplung	Glocke
X8								
400 cc SX	2006 >	FD.0365	*****	*****	*****	2006 >	FC.1377	G.0708
400 cc DX	2006 >	FD.0330	FD.0330	*****	*****	2006 >	FC.1377	G.0708
X9								
500 cc	2001 > 2003	FD.0256	FD.0256	DF.4056	DF.4055	2001 > 2003	FC.1366	G.0708
X9 Amalfi								
180 cc	2001 >	FD.0256	FD.0256	DF.4042	DF.4042	2000 >	FC.1365	G.0705
250 cc	2000 >	FD.0256	FD.0256	DF.4042	DF.4042	2000 >	FC.1352	G.0697
X9 Evolution								
125 cc Heng Tong SX	2001 >	FD.0330	*****	DF.4042	DF.4042	2001 >	FC.1362	G.0705
125 cc Heng Tong DX	2001 >	FD.0365	FD.0394	DF.4042	DF.4042	2001 >	FC.1362	G.0705
125 cc	2006 >	FD.0256	FD.0256	DF.4042	DF.4042	2003 >	FC.1378	G.0715
125 cc	2006 >	FD.0365	FD.0256	DF.4042	DF.4042	2003 >	FC.1378	G.0715
200 cc	2003 >	FD.0256	FD.0256	DF.4042	DF.4042	2003 >	FC.1368	G.0705
250 cc Heng Tong SX	2004	FD.0365	*****	DF.4042	*****	2004 > 2006	FC.1385	G.0715
250 cc Heng Tong DX	2004	FD.0330	FD.0256	DF.4042	DF.4042	2004 > 2006	FC.1385	G.0715
250 cc Heng Tong SX	2005 > 2006	FD.0365	*****	DF.4042	*****	2004 > 2006	FC.1385	G.0715
250 cc Heng Tong DX	2005 > 2006	FD.0330	FD.0394	DF.4042	DF.4042	2004 > 2006	FC.1385	G.0715
500 cc	2003 > 2004	FD.0186	FD.0256	DF.4071	DF.4055	2003 >	FC.1370	G.0708
500 cc ABS	2005 >	FD.0186	FD.0256	DF.4071	DF.4055	2003 >	FC.1370	G.0708
500 cc ABS	2005 >	FD.0186	FD.0256	DF.4071	DF.4055	2006 > 2007	FC.1377	G.0708
Zip								
50 cc	1992 > 1993	GF.0257	GF.0252	()	()	1992 >	FC.1333	G.0685
50 cc	1999 >	GF.0266	GF.0261	()	()	1999 >	FC.1333	G.0685
125 cc	2000 >	FD.0249	GF.0261	*****	()	2000 >	FC.1362	G.0705
Zip Fast Raider								
50 cc	1993 > 1995	FD.0196	GF.0263	DF.4004	()	1993 >	FC.1333	G.0685
Zip Fast Raider								
50 cc	1995 >	FD.0196	GF.0261	DF.4004	()	1995 >	FC.1333	G.0685
Zip Rst.								
50 cc	1996 > 1997	FD.0247	GF.0261	DF.4004	()	1996 >	FC.1333	G.0685
50 cc	1998 >	FD.0249	GF.0266	DF.4004	()	1998 >	FC.1333	G.0685
Zip SP								
50 cc	1996 >	FD.0249	GF.0261	DF.4012	()	1996 >	FC.1333	G.0685
Suzuki								
	Jahr	Beläge VR	Beläge HR	Scheibe VR	Scheibe HR	Jahr	Kupplung	Glocke
Address								
50 cc	1990 > 1991	GF.1297	GF.1297	()	()	1990 >	FC.1334	*****
50 cc	1992 >	FD.0085	GF.1297	*****	()	*****	*****	*****
50 cc	1993 >	GF.1297	GF.1297	()	()	*****	*****	*****
100 cc	1995 >	FD.0061	GF.1300	*****	()	*****	*****	*****
AH								
50 cc	1993 >	GF.1297	GF.1297	()	()	*****	*****	*****
125 cc	1995 > 2002	FD.0222	GF.1233	*****	()	*****	*****	*****
AP								
50 cc	1971 >	GF.1146	GF.1146	()	()	*****	*****	*****
50 cc	1995 >	FD.0197	GF.1146	*****	()	1995 >	FC.1334	
AN Burgman								
250 cc	1996 > 2000	FD.0264	FD.0265	*****	*****	1998 >	FC.1353	G.0696
250 cc	2001 > 2006	FD.0264	FD.0326	DF.4084	DF.4085	1998 >	FC.1353	G.0696
400 cc	1998 > 2000	FD.0264	FD.0265	*****	*****	1999 >	FC.1357	G.0701
400 cc	2001 > 2006	FD.0264	FD.0326	DF.4084	DF.4085	1999 >	FC.1357	G.0701
400 cc DX	2007 > 2009	FD.0163	FD.0356	DF.4084	*****	*****	*****	*****



Scooter-Beläge + Backen + Kupplung + Glocke Plaquette + mâchoire-Scooter

98



Suzuki	Jahr	Beläge VR	Beläge HR	Scheibe VR	Scheibe HR	Jahr	Kupplung	Glocke
AN Burgman								
400 cc SX	2007>2009	FD.0122	*****	DF.4084	*****	*****	*****	*****
AY AYW K1-K4								
50 cc Katana (Brembo)	1997>	FD.0196	GF.1233	*****	()	*****	*****	*****
50 cc WR Katana	1998>	FD.0094	GF.1233	*****	()	*****	*****	*****
50 cc W Katana	1998>	FD.0094	GF.1233	*****	()	*****	*****	*****
50 cc W (Katana)	2000>2004	FD.0094	GF.1233	*****	()	*****	*****	*****
50 CC A	2004>2006	FD.0094	FD.0094	*****	*****	*****	*****	*****
Sepia AJ/ZZ/Tune								
50 cc	1992>	FD.0085	GF.1233	*****	*****	1992>	FC.1334	
50 cc	1996>	FD.0085	GF.1297	*****	*****	1995>	FC.1334	
TR S Street Magic								
50 cc	1998>	FD.0222	GF.1300	*****	*****	*****	*****	*****
UC Epicuro X-K1								
125 cc	1998>2000	FD.0222	GF.1309	*****	()	*****	*****	*****
125 cc	2001>	FD.0222	FD.0222	*****	*****	*****	*****	*****
150 cc	>2000	FD.0222	GF.1309	*****	()	*****	*****	*****
150 cc	2001>	FD.0222	FD.0222	*****	*****	*****	*****	*****
UF Estilete								
50 cc	2000>	FD.0094	*****	*****	*****	*****	*****	*****
UG Hokuto								
50 cc	2000>	FD.0222	GF.1300	*****	()	*****	*****	*****
UX W Zillion								
50 cc	1998>	FD.0094	GF.	*****	()	*****	*****	*****
125 cc	2008>	FD.0400	FD.0326	*****	*****	*****	*****	*****
150 cc	2008>	FD.0400	FD.0326	*****	*****	*****	*****	*****
Yamaha								
Aerox LC								
50 cc	1997>	FD.0197	FD.0251	DF.4066	DF.4066	1997>	FC.1349	G.0684
Beluga								
50 cc	>1989	GF.1217	GF.1217	()	()	*****	*****	*****
50 cc	1990>	GF.1187	GF.1217	()	()	1989>	FC.1331	G.0683
Yamy + ME								
50 cc	1988>	GF.1278	GF.1278	()	()	*****	*****	*****
BW'S								
50 cc	1992>1994	GF.1187	GF.1187	()	()	1992>1996	FC.1331	G.0683
BW'S R								
50 cc	1995>	FD.0196	GF.1187	DF.4004	()	1997>	FC.1349	G.0684
BW								
50 cc	1991>	GF.1187	GF.1187	()	()	*****	*****	*****
BW BUMP								
50 cc	1997>	FD.0196	GF.1187	*****	()	*****	*****	*****
BW SPY								
50 cc	1995>1999	FD.0196	GF.1200	*****	()	>1996	FC.1331	G.0683
50 cc	2000>	FD.0196	GF.1187	*****	()	1997>	FC.1349	G.0684
BW Next Generation								
50 cc	1996>	FD.0196	GF.1187	*****	()	*****	*****	*****
BW Sports Spec R								
50 cc	2002>	FD.0196	GF.1187	*****	()	*****	*****	*****
FLY ONE								
50 cc	1992>	FD.0124	GF.1043	*****	()	*****	*****	*****



Scooter-Beläge + Backen + Kupplung + Glocke Plaquette + mâchoire-Scooter

98



Yamaha	Jahr	Beläge VR	Beläge HR	Scheibe VR	Scheibe HR	Jahr	Kupplung	Glocke
CR Z + Target								
50 cc	1991 >	FD.0175	GF.1200	DF.4004	()	1991 >	FC.1331	G.0683
CT Super Sport								
50 cc	1990 >	GF.1200	GF.1200	()	()	****	****	****
CV JOG + ZR Evolution								
50 cc	2000 > 2002	FD.0377	****	****	****	1997 >	FC.1349	G.0684
CY JOG								
50 cc	1990 >	GF.1217	GF.1187	()	()	1988 > 1996	FC.1331	G.0683
EW Slider								
50 cc	2000 >	FD.0196	GF.	****	()	****	****	****
NXC Cignus X								
125 cc	2004 > 2007	FD.0414	GF.1318	DF.4099	()	2004 > 2007	FC.1360	G.0704
XC Beluga								
125 cc	1993 >	GF.1270	GF.1105	()	()	****	****	****
XC TR Cygnus R								
125 cc	1996 >	FD.0124	GF.1200	DF.4087	()	****	****	****
XC Fly One								
150 cc	1990 > 1995	FD.0124	GF.1043	DF.4087	()	****	****	****
150 cc	1990 > 1995	FD.0124	GF.1303	DF.4087	()	****	****	****
XC Cygnus R								
125 cc	1996 > 2003	FD.0124	GF.1200	****	()	1999 > 2003	FC.1360	G.0704
XC K Cygnus R								
125 cc	1997 > 1998	FD.0124	GF.1200	****	()	****	****	****
XC T Cygnus R								
125 cc	1995 > 1998	GF.1303	GF.1200	()	()	****	****	****
XC Versity								
300 cc	2003 > 2006	FD.0186	FD.0186	DF.4077	DF.4078	2003 >	FC.1367	G.0709
XN Teo's								
125 cc	2000 > 2001	FD.0196	GF.1303	****	()	****	****	****
150 cc	2001 > 2002	FD.0196	GF.1303	****	()	2001 > 2002	FC.1361	G.0698
XP TMAX								
500 cc	2001 > 2003	FD.0183	FD.0316	DF.5078	DF.5079	****	****	****
500 cc ABS	2004 > 2007	FD.0205	FD.0378	DF.5078	DF.5079	****	****	****
500 cc ABS	2008 > 2009	FD.0190	FD.0378	DF.5078	DF.5079	****	****	****
XQ Maxster								
125 cc	2001 > 2002	FD.0186	FD.0256	****	****	2001 > 2002	FC.1360	G.0704
150 cc	2001 > 2002	FD.0186	FD.0256	****	****	2001 > 2002	FC.1361	G.0698
YA R Axis								
50 cc	1993 >	FD.0175	GF.0255	DF.4004	()	1993 >	FC.1331	G.0683
50 cc	2002 >	FD.0197	GF.	DF.4004	()	****	****	****
YH WHY								
50 cc	1997 >	FD.0196	GF.1187	****	()	1998 >	FC.1349	G.0684
YM Breeze								
50 cc	1994 >	FD.0196	GF.1187	DF.4004	()	1994 > 1996	FC.1331	G.0683
50 cc	1994 >	FD.0196	GF.1187	DF.4004	()	1997 >	FC.1349	G.0684
YN Neo's								
50 cc	1997 >	FD.0197	GF.1200	****	()	1997 >	FC.1349	G.0684
YP E Majesty								
125 cc	2003 > 2008	FD.0186	FD.0256	DF.4026	DF.4067	2003 >	****	G.0698
180 cc	> 2003	FD.0186	GF.1303	****	()	2003 >	****	G.0698
180 cc	2003 > 2006	FD.0186	FD.0256	****	****	****	****	****



Scooter-Beläge + Backen + Kupplung + Glocke Plaquette + mâchoire-Scooter

98



Yamaha		Jahr	Beläge VR	Beläge HR	Scheibe VR	Scheibe HR	Jahr	Kupplung	Glocke
YP Majesty									
125 cc	1998>2000	FD.0186	GF.1303	DF.4026	()	1998>	FC.1360	G.0704	
125 cc	2001>2002	FD.0186	GF.1303	DF.4026	()	2001>2002	FC.1360	G.0704	
150 cc	>2000	FD.0186	GF.1303	DF.4026	()	****	****	****	
150 cc	2001>2002	FD.0186	FD.0256	DF.4026	DF.4067	2000>	FC.1361	G.0698	
250 CC	1996>1997	FD.0205	GF.1197	DF.4023	()	1996>1998	FC.1351	G.0698	
250 CC A	2000>	FD.0205	FD.0259	DF.4023	DF.4045	2000>	FC.1367	G.0709	
400 cc	>2004	FD.0183	FD.0378	DF.4088	DF.4101	****	****	****	
400 cc	2005>2006	FD.0205	FD.0378	****	DF.4101	2004>2006	FC.1381	G.0717	
400 cc	2007>2009	FD.0205	FD.0378	****	DF.4089	****	****	****	
YP Majesty DX - ABS									
250 CC	1998>1999	FD.0205	FD.0259	DF.4023	DF.4027	1998>2000	FC.1351	G.0698	
400 cc	2007>2009	FD.0205	FD.0378	****	DF.4089	****	****	****	
YP RX X MAX									
125 CC	2006>2009	FD.0396	FD.0256	DF.4088	****	****	****	****	
YQ Aerox LC									
50 cc	1997>	FD.0197	FD.0251	DF.4066	DF.4066	1997>	FC.1349	G.0684	



NEWFREN

FD.0012
Art.-Nr. Ref. VP sFr
98.1000 Sinter 13.20
98.1001 Organ 15.30

NEWFREN

FD.0013
Art.-Nr. Ref. VP sFr
98.1002 26.15

NEWFREN

FD.0048
Art.-Nr. Ref. VP sFr
98.1003 13.20

NEWFREN

FD.0054
Art.-Nr. Ref. VP sFr
98.1005 32.80

NEWFREN

FD.0058
Art.-Nr. Ref. VP sFr
98.1006 35.85

NEWFREN

FD.0061
Art.-Nr. Ref. VP sFr
98.1004 24.90



Scooter-Beläge + Backen + Kupplung + Glocke Plaquette + mâchoire-Scooter

98

NEWFREN

FD.0067
Art.-Nr. Ref VP sFr **41.55**

NEWFREN

FD.0073
Art.-Nr. Ref VP sFr **21.60**

NEWFREN

FD.0074
Art.-Nr. Ref VP sFr **13.20**

NEWFREN

FD.0085
Art.-Nr. Ref VP sFr **20.80**

NEWFREN

FD.0091
Art.-Nr. Ref VP sFr **17.00**
98.1013 Sinter **19.55**
98.1014 Organ

NEWFREN

FD.0093
Art.-Nr. Ref VP sFr **40.60**

NEWFREN

FD.0094
Art.-Nr. Ref VP sFr **15.95**

NEWFREN

FD.0098
Art.-Nr. Ref VP sFr **13.20**

NEWFREN

FD.0108
Art.-Nr. Ref VP sFr **43.60**

NEWFREN

FD.0113
Art.-Nr. Ref VP sFr **39.15**

NEWFREN

FD.0114
Art.-Nr. Ref VP sFr **29.00**

NEWFREN

FD.0115
Art.-Nr. Ref VP sFr **3355**



Scooter-Beläge + Backen + Kupplung + Glocke Plaquette + mâchoire-Scooter

98

NEWFREN

FD.0122
Art.-Nr. Ref VP sFr **29.85**

NEWFREN

FD.0124
Art.-Nr. Ref VP sFr **30.20**

NEWFREN

FD.0132
Art.-Nr. Ref VP sFr **35.60**

NEWFREN

FD.0136
Art.-Nr. Ref VP sFr **34.80**

NEWFREN

FD.0139
Art.-Nr. Ref VP sFr **22.40**

NEWFREN

FD.0162
Art.-Nr. Ref VP sFr **22.80**

NEWFREN

FD.0163
Art.-Nr. Ref VP sFr **30.65**

NEWFREN

FD.0165
Art.-Nr. Ref VP sFr **20.65**

NEWFREN

FD.0166
Art.-Nr. Ref VP sFr **29.40**

NEWFREN

FD.0173
Art.-Nr. Ref VP sFr **17.00**

NEWFREN

FD.0175
Art.-Nr. Ref VP sFr **17.00**

NEWFREN

FD.0178
Art.-Nr. Ref VP sFr **27.05**



Scooter-Beläge + Backen + Kupplung + Glocke Plaquette + mâchoire-Scooter

98

NEWFREN

FD.0183
Art.-Nr. Ref VP sFr **34.80**

NEWFREN

FD.0186
Art.-Nr. Ref VP sFr **26.50**

NEWFREN

FD.0190
Art.-Nr. Ref VP sFr **32.35**

NEWFREN

FD.0192
Art.-Nr. Ref VP sFr **17.00**

NEWFREN

FD.0193
Art.-Nr. Ref VP sFr **28.20**

NEWFREN

FD.0194
Art.-Nr. Ref VP sFr **13.20**

NEWFREN

FD.0195
Art.-Nr. Ref VP sFr **23.20**

NEWFREN

FD.0196
Art.-Nr. Ref VP sFr **13.20**

NEWFREN

FD.0197
Art.-Nr. Ref VP sFr **13.20**

NEWFREN

FD.0205
Art.-Nr. Ref VP sFr **30.65**

NEWFREN

FD.0213
Art.-Nr. Ref VP sFr **50.00**

NEWFREN

FD.0216
Art.-Nr. Ref VP sFr **35.60**



Scooter-Beläge + Backen + Kupplung + Glocke Plaquette + mâchoire-Scooter

98

NEWFREN

FD.0219
Art.-Nr. Ref VP sFr **25.60**

NEWFREN

FD.0221
Art.-Nr. Ref VP sFr **32.35**

NEWFREN

FD.0222
Art.-Nr. Ref VP sFr **31.85**

NEWFREN

FD.0223
Art.-Nr. Ref VP sFr **27.30**

NEWFREN

FD.0224
Art.-Nr. Ref VP sFr **31.40**

NEWFREN

FD.0225
Art.-Nr. Ref VP sFr **15.20**

NEWFREN

FD.0226
Art.-Nr. Ref VP sFr **25.45**

NEWFREN

FD.0230
Art.-Nr. Ref VP sFr **26.60**

NEWFREN

FD.0247
Art.-Nr. Ref VP sFr **13.20**

NEWFREN

FD.0249
Art.-Nr. Ref VP sFr **15.90**

NEWFREN

FD.0251
Art.-Nr. Ref VP sFr **13.60**

NEWFREN

FD.0254
Art.-Nr. Ref VP sFr **33.15**



Scooter-Beläge + Backen + Kupplung + Glocke Plaquette + mâchoire-Scooter

98

NEWFREN

FD.0255
Art.-Nr. Ref VP sFr **33.15**

NEWFREN

FD.0256
Art.-Nr. Ref VP sFr **24.80**

NEWFREN

FD.0257
Art.-Nr. Ref VP sFr **29.60**

NEWFREN

FD.0259
Art.-Nr. Ref VP sFr **32.40**

NEWFREN

FD.0263
Art.-Nr. Ref VP sFr **17.00**

NEWFREN

FD.0264
Art.-Nr. Ref VP sFr **49.70**

NEWFREN

FD.0266
Art.-Nr. Ref VP sFr **15.20**

NEWFREN

FD.0267
Art.-Nr. Ref VP sFr **15.90**

NEWFREN

FD.0269
Art.-Nr. Ref VP sFr **24.80**

NEWFREN

FD.0271
Art.-Nr. Ref VP sFr **15.25**

NEWFREN

FD.0281
Art.-Nr. Ref VP sFr **37.60**

NEWFREN

FD.0282
Art.-Nr. Ref VP sFr **31.55**



Scooter-Beläge + Backen + Kupplung + Glocke Plaquette + mâchoire-Scooter

98

NEWFREN

FD.0298
Art.-Nr. Ref VP sFr **24.20**

NEWFREN

FD.0304
Art.-Nr. Ref VP sFr **31.95**

NEWFREN

FD.0305
Art.-Nr. Ref VP sFr **67.95**

NEWFREN

FD.0316
Art.-Nr. Ref VP sFr **30.65**

NEWFREN

FD.0323
Art.-Nr. Ref VP sFr **26.75**

NEWFREN

FD.0324
Art.-Nr. Ref VP sFr **38.10**

NEWFREN

FD.0326
Art.-Nr. Ref VP sFr **39.15**

NEWFREN

FD.0327
Art.-Nr. Ref VP sFr **53.15**

NEWFREN

FD.0328
Art.-Nr. Ref VP sFr **26.75**

NEWFREN

FD.0330
Art.-Nr. Ref VP sFr **29.05**

NEWFREN

FD.0334
Art.-Nr. Ref VP sFr **27.70**

NEWFREN

FD.0335
Art.-Nr. Ref VP sFr **24.80**



Scooter-Beläge + Backen + Kupplung + Glocke Plaquette + mâchoire-Scooter

98

NEWFREN

FD.0356
Art.-Nr. Ref VP sFr **38.10**

NEWFREN

FD.0357
Art.-Nr. Ref VP sFr **29.60**

NEWFREN

FD.0365
Art.-Nr. Ref VP sFr **28.65**

NEWFREN

FD.0378
Art.-Nr. Ref VP sFr **32.35**

NEWFREN

FD.0380
Art.-Nr. Ref VP sFr **31.55**

NEWFREN

FD.0383
Art.-Nr. Ref VP sFr **33.15**

NEWFREN

FD.0392
Art.-Nr. Ref VP sFr **23.20**

NEWFREN

FD.0394
Art.-Nr. Ref VP sFr **24.80**

NEWFREN

FD.0396
Art.-Nr. Ref VP sFr **35.30**

NEWFREN

FD.0400
Art.-Nr. Ref VP sFr **36.20**

NEWFREN

FD.0414
Art.-Nr. Ref VP sFr **31.95**

NEWFREN

FD.0439
Art.-Nr. Ref VP sFr **23.20**



Scooter-Beläge + Backen + Kupplung + Glocke Plaquette + mâchoire-Scooter

98

NEWFREN

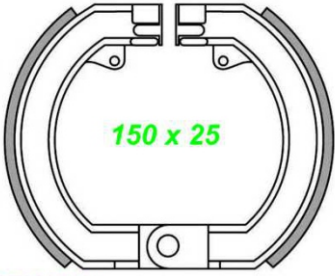

150 x 25

GF.0024
Art.-Nr. Ref VP sFr **27.85**

98.1104

NEWFREN

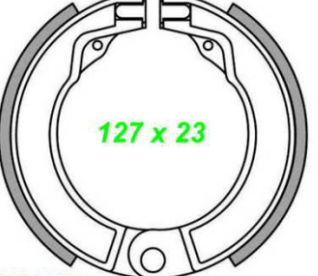

127 x 23

GF.0087
Art.-Nr. Ref VP sFr **25.00**

98.1157

NEWFREN



135 x 23

GF.0127
Art.-Nr. Ref VP sFr **23.85**

98.1111

NEWFREN

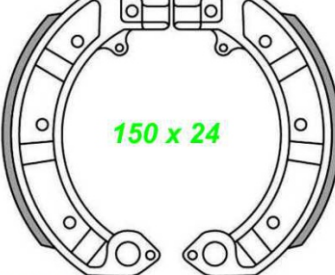

150 x 24

GF.0128
Art.-Nr. Ref VP sFr **15.95**

98.1146

NEWFREN

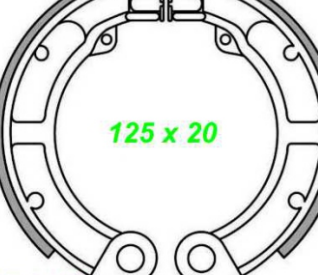

125 x 20

GF.0130
Art.-Nr. Ref VP sFr **13.95**

98.1112

NEWFREN

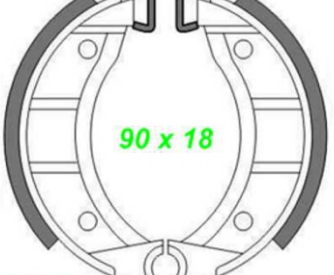

90 x 18

GF.0151
Art.-Nr. Ref VP sFr **14.10**

98.1113

NEWFREN

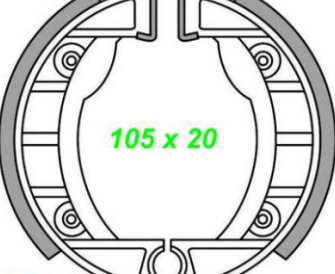

105 x 20

GF.0152
Art.-Nr. Ref VP sFr **14.60**

95.414497

NEWFREN



118 x 20

GF.0153
Art.-Nr. Ref VP sFr **13.95**

98.1114

NEWFREN

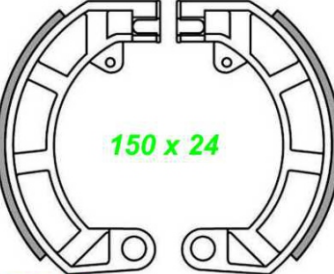

150 x 24

GF.0159
Art.-Nr. Ref VP sFr **12.50**

98.1115

NEWFREN



125 x 17

GF.0162
Art.-Nr. Ref VP sFr **13.95**

98.1116

NEWFREN



135 x 16

GF.0190
Art.-Nr. Ref VP sFr **12.00**

95.414557

NEWFREN



90 x 18

GF.0210
Art.-Nr. Ref VP sFr **14.10**

83.1105



Scooter-Beläge + Backen + Kupplung + Glocke Plaquette + mâchoire-Scooter

98

NEWFREN



150 x 24

GF.0224
Art.-Nr. Ref VP sFr **30.90**

NEWFREN



140 x 25

GF.0227
Art.-Nr. Ref VP sFr **34.25**

NEWFREN



118 x 24

GF.0244
Art.-Nr. Ref VP sFr **27.80**

NEWFREN

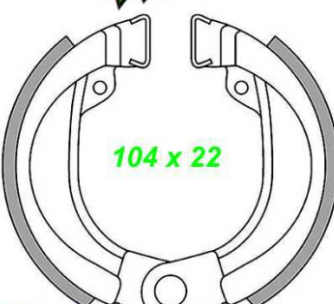

104 x 22

GF.0245
Art.-Nr. Ref VP sFr **27.05**

NEWFREN



170 x 25

GF.0249
Art.-Nr. Ref VP sFr **25.00**

NEWFREN



170 x 25

GF.0250
Art.-Nr. Ref VP sFr **34.60**

NEWFREN

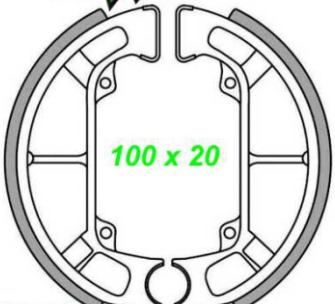

100 x 20

GF.0252
Art.-Nr. Ref VP sFr **12.50**

NEWFREN

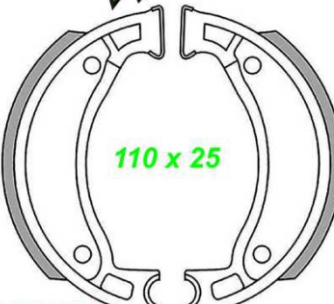

110 x 25

GF.0253
Art.-Nr. Ref VP sFr **25.00**

NEWFREN

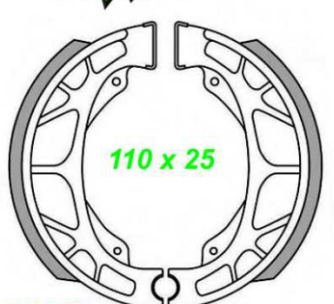

110 x 25

GF.0255
Art.-Nr. Ref VP sFr **15.95**

NEWFREN

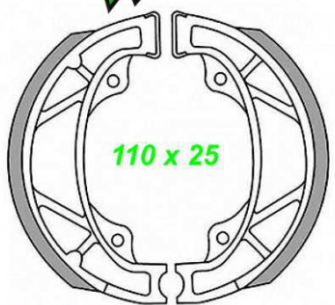

110 x 25

GF.0256
Art.-Nr. Ref VP sFr **27.85**

NEWFREN

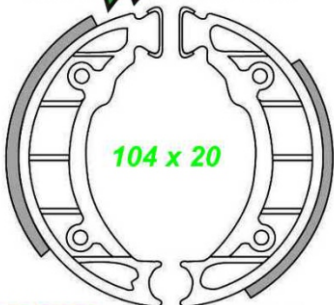

104 x 20

GF.0257
Art.-Nr. Ref VP sFr **11.20**

NEWFREN

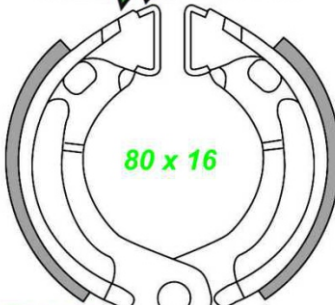

80 x 16

GF.0260
Art.-Nr. Ref VP sFr **15.20**



Scooter-Beläge + Backen + Kupplung + Glocke Plaquette + mâchoire-Scooter

98

NEWFREN



110 x 25

GF.0261
Art.-Nr. Ref VP sFr **18.40**

NEWFREN



125 x 25

GF.0262
Art.-Nr. Ref VP sFr **25.00**

NEWFREN



100 x 20

GF.0263
Art.-Nr. Ref VP sFr **13.20**

NEWFREN

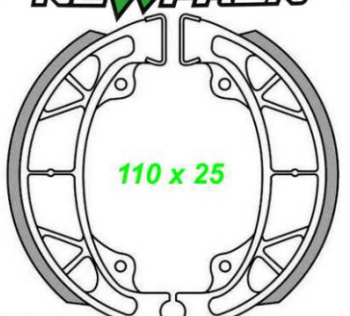

110 x 25

GF.0264
Art.-Nr. Ref VP sFr **19.40**

NEWFREN



150 x 18

GF.0265
Art.-Nr. Ref VP sFr **22.75**

NEWFREN



105 x 22

GF.0266
Art.-Nr. Ref VP sFr **22.75**

NEWFREN

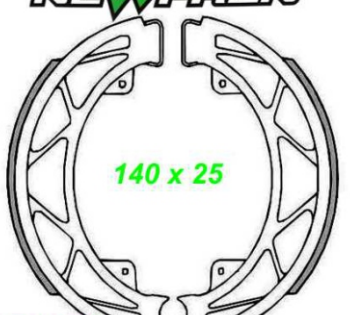

140 x 25

GF.0267
Art.-Nr. Ref VP sFr **25.60**

NEWFREN



140 x 25

GF.0268
Art.-Nr. Ref VP sFr **25.60**

NEWFREN



110 x 25

GF.1043
Art.-Nr. Ref VP sFr **16.80**

NEWFREN



80 x 18

GF.1093
Art.-Nr. Ref VP sFr **18.60**

NEWFREN



130 x 28

GF.1105
Art.-Nr. Ref VP sFr **26.40**

NEWFREN



80 x 18

GF.1143
Art.-Nr. Ref VP sFr **14.10**



Scooter-Beläge + Backen + Kupplung + Glocke Plaquette + mâchoire-Scooter

98

NEWFREN

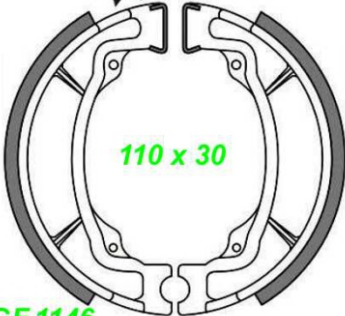

110 x 30

GF.1146
Art.-Nr. 98.1126 Ref VP sFr 27.80

NEWFREN

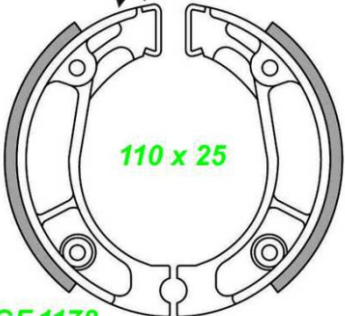

110 x 25

GF.1178
Art.-Nr. 98.1127 Ref VP sFr 22.75

NEWFREN

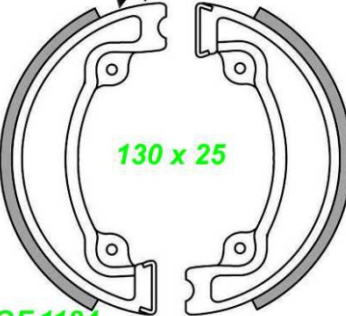

130 x 25

GF.1184
Art.-Nr. 98.1128 Ref VP sFr 39.40

NEWFREN

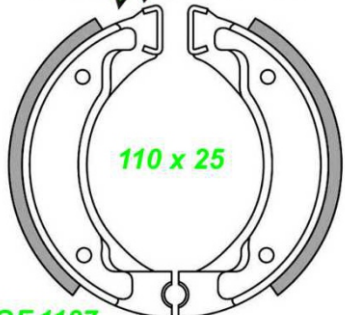

110 x 25

GF.1187
Art.-Nr. 98.1130 Ref VP sFr 15.70

NEWFREN



110 x 25

GF.1188
Art.-Nr. 98.1131 Ref VP sFr 20.75

NEWFREN

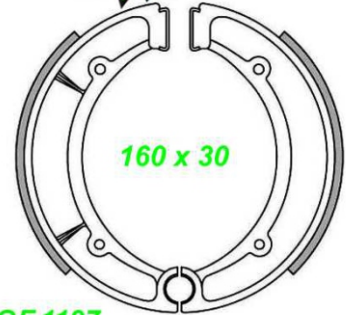

160 x 30

GF.1197
Art.-Nr. 98.1129 Ref VP sFr 51.55

NEWFREN

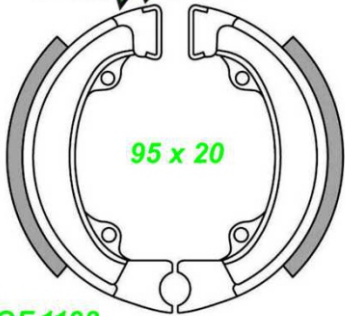

95 x 20

GF.1198
Art.-Nr. 98.1133 Ref VP sFr 15.70

NEWFREN

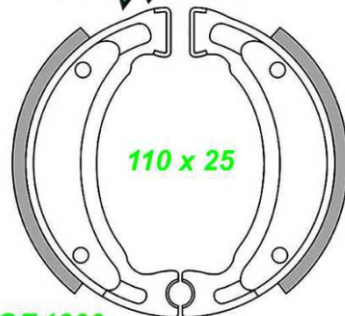

110 x 25

GF.1200
Art.-Nr. 98.1134 Ref VP sFr 15.70

NEWFREN

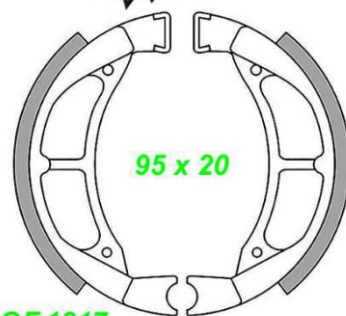

95 x 20

GF.1217
Art.-Nr. 98.1136 Ref VP sFr 17.55

NEWFREN

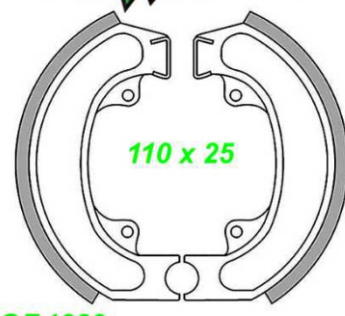

110 x 25

GF.1229
Art.-Nr. 98.1137 Ref VP sFr 20.65

NEWFREN

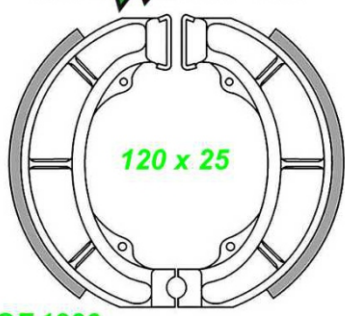

120 x 25

GF.1233
Art.-Nr. 98.1138 Ref VP sFr 25.95

NEWFREN



95 x 20

GF.1246
Art.-Nr. 98.1132 Ref VP sFr 20.35



Scooter-Beläge + Backen + Kupplung + Glocke Plaquette + mâchoire-Scooter

98

NEWFREN

95 x 20

GF.1248
Art.-Nr. Ref VP sFr **19.40**

NEWFREN

130 x 28

GF.1270
Art.-Nr. Ref VP sFr **27.85**

NEWFREN

105 x 25

GF.1277
Art.-Nr. Ref VP sFr **15.70**

NEWFREN

100 x 20

GF.1278
Art.-Nr. Ref VP sFr **20.35**

NEWFREN

130 x 25

GF.1289
Art.-Nr. Ref VP sFr **29.95**

NEWFREN

90 x 20

GF.1297
Art.-Nr. Ref VP sFr **18.75**

NEWFREN

110 x 23

GF.1300
Art.-Nr. Ref VP sFr **25.00**

NEWFREN

130 x 28

GF.1303
Art.-Nr. Ref VP sFr **33.00**

NEWFREN

160 x 30

GF.1307
Art.-Nr. Ref VP sFr **39.70**

NEWFREN

130 x 20

GF.1308
Art.-Nr. Ref VP sFr **25.95**

NEWFREN

130 x 28

GF.1309
Art.-Nr. Ref VP sFr **27.40**

NEWFREN

130 x 25

GF.1310
Art.-Nr. Ref VP sFr **28.50**



Scooter-Beläge + Backen + Kupplung + Glocke Plaquette + mâchoire-Scooter

98

NEWFREN

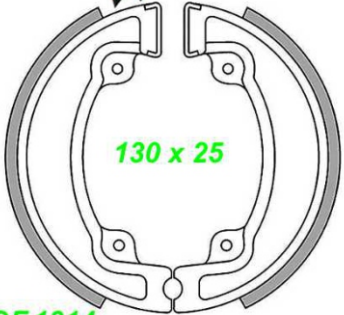

130 x 25

GF.1314
Art.-Nr. Ref VP sFr **39.40**

NEWFREN

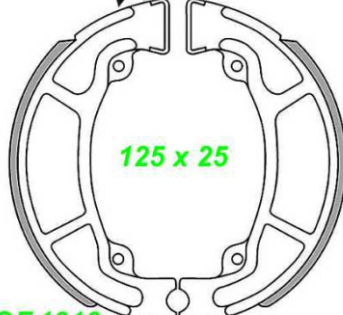

125 x 25

GF.1316
Art.-Nr. Ref VP sFr **28.50**

NEWFREN

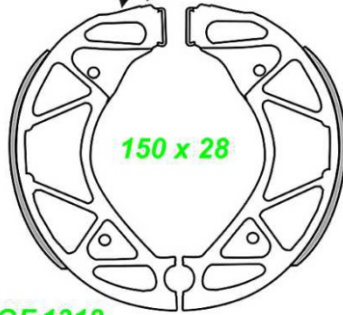

150 x 28

GF.1318
Art.-Nr. Ref VP sFr **44.00**

NEWFREN DF.4001

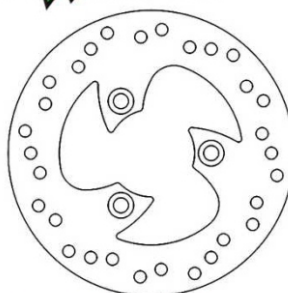

Ø 190/79.5/58.2 x 8.5 mm

Art.-Nr. Ref VP sFr **42.50**

NEWFREN DF.4004

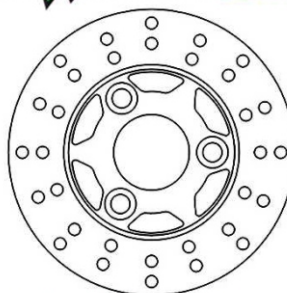

Ø 155/66/40.8 x 10.5 mm

Art.-Nr. Ref VP sFr **44.80**

NEWFREN DF.4005

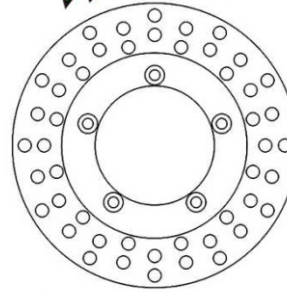

Ø 175/86.5/73.3 x 6.5 mm

Art.-Nr. Ref VP sFr **67.15**

NEWFREN DF.4006

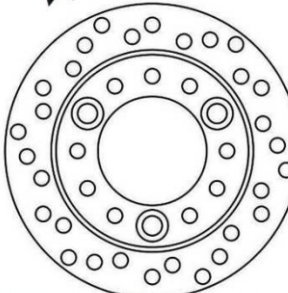

Ø 157.5/80/58.2 x 10.5 mm

Art.-Nr. Ref VP sFr **51.40**

NEWFREN DF.4009

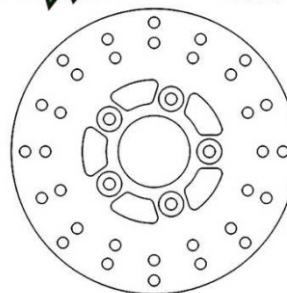

Ø 155/60/30 x 6.4 mm

Art.-Nr. Ref VP sFr **58.10**

NEWFREN DF.4012



Ø 200/107/96 x 6.5 mm

Art.-Nr. Ref VP sFr **56.00**

NEWFREN DF.4014

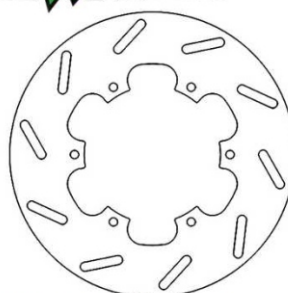

Ø 220/120/105 x 6.5 mm

Art.-Nr. Ref VP sFr **59.70**

NEWFREN DF.4016

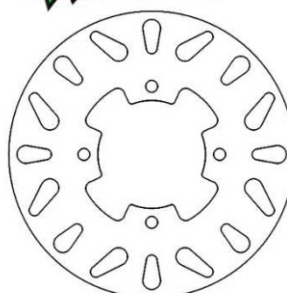

Ø 160/76/60.2 x 6.5 mm

Art.-Nr. Ref VP sFr **81.15**

NEWFREN DF.4017

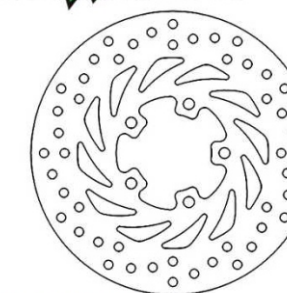

Ø 220/80/60 x 8 mm

Art.-Nr. Ref VP sFr **68.00**



Scooter-Beläge + Backen + Kupplung + Glocke Plaquette + mâchoire-Scooter

98

NEWFREN DF.4023

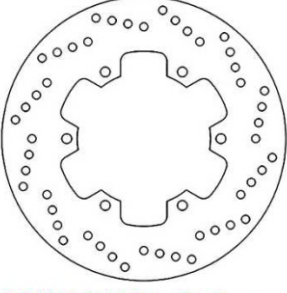

Ø 245/133/115 x 8.4 mm
Art.-Nr. 98.1216 Ref. VP sFr 94.40

NEWFREN DF.4025

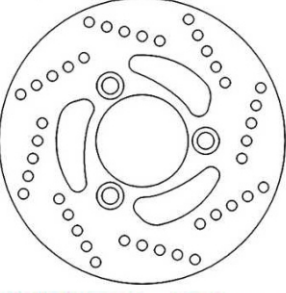

Ø 180/80/58.2 x 10.6 mm
Art.-Nr. 98.1219 Ref. VP sFr 66.25

NEWFREN DF.4026

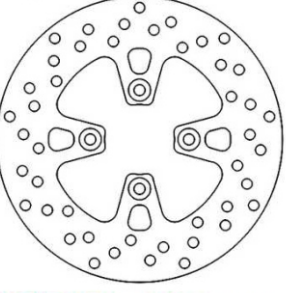

Ø 220/76/54 x 10.6 mm
Art.-Nr. 98.1221 Ref. VP sFr 91.40

NEWFREN DF.4028



Ø 174/60/38 x 6.5 mm
Art.-Nr. 98.1223 Ref. VP sFr 97.80

NEWFREN DF.4029

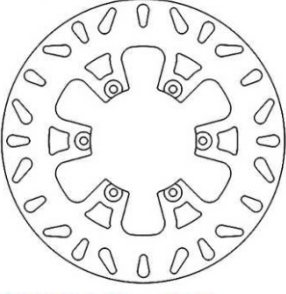

Ø 240/101/90 x 6.5 mm
Art.-Nr. 98.1224 Ref. VP sFr 88.80

NEWFREN DF.4030

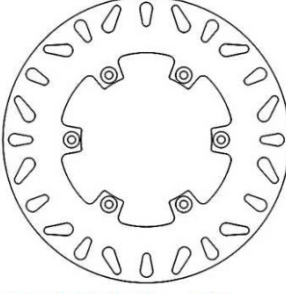

Ø 230/120/105 x 6.2 mm
Art.-Nr. 98.1225 Ref. VP sFr 114.40

NEWFREN DF.4031

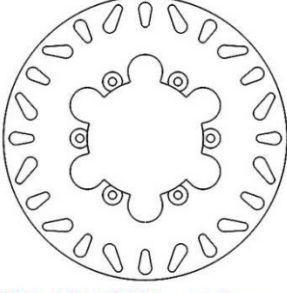

Ø 220/101.5/90 x 6.3 mm
Art.-Nr. 98.1226 Ref. VP sFr 86.25

NEWFREN DF.4032

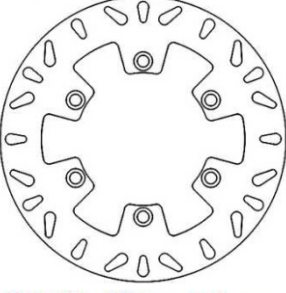

Ø 220/101.5/90 x 6.3 mm
Art.-Nr. 98.1227 Ref. VP sFr 86.25

NEWFREN DF.4033

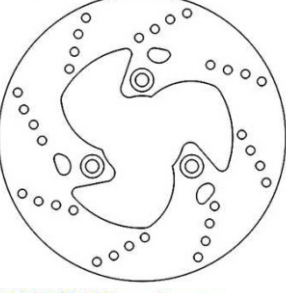

Ø 200/80/58 x 9 mm
Art.-Nr. 98.1228 Ref. VP sFr 69.60

NEWFREN DF.4034

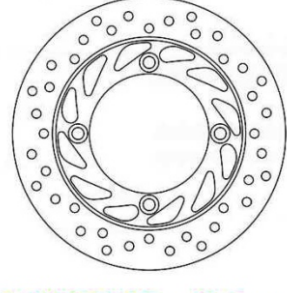

Ø 240/125/105 x 10.5 mm
Art.-Nr. 98.1234 Ref. VP sFr 82.40

NEWFREN DF.4036

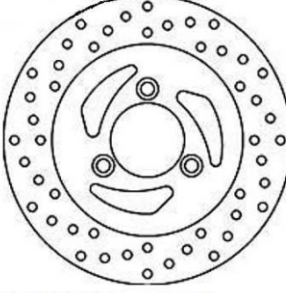

Ø 226/80/58 x 10.5 mm
Art.-Nr. 98.1229 Ref. VP sFr 74.60

NEWFREN DF.4038

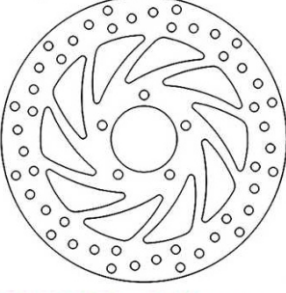

Ø 260/80/60 x 8.5 mm
Art.-Nr. 98.1238 Ref. VP sFr 92.80



Scooter-Beläge + Backen + Kupplung + Glocke Plaquette + mâchoire-Scooter

98

NEWFREN DF.4039



Ø 280/170/155 x 6.5 mm

Art.-Nr.	Ref	VP sFr
98.1239	<input type="text"/>	163.20

NEWFREN DF.4042

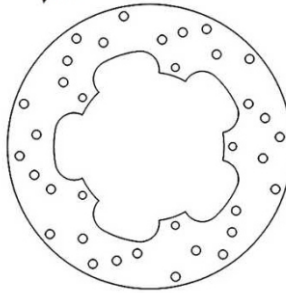

Ø 240/140/125.5 x 6.5 mm

Art.-Nr.	Ref	VP sFr
98.1242	<input type="text"/>	46.40

NEWFREN DF.4043

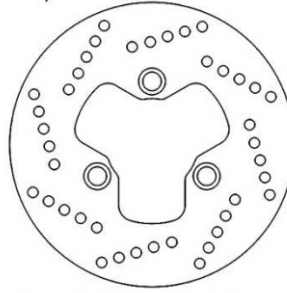

Ø 180/80/58.2 x 11.8 mm

Art.-Nr.	Ref	VP sFr
98.1230	<input type="text"/>	95.85

NEWFREN DF.4045

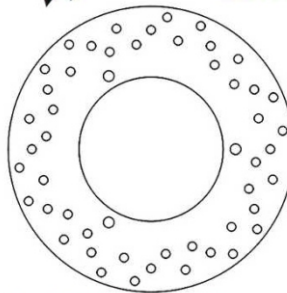

Ø 230/136/116 x 8.5 mm

Art.-Nr.	Ref	VP sFr
98.1232	<input type="text"/>	97.80

NEWFREN DF.4050

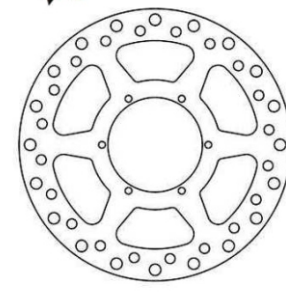

Ø 260/101.6/90.5 x 6.5 mm

Art.-Nr.	Ref	VP sFr
98.1250	<input type="text"/>	73.00

NEWFREN DF.4053

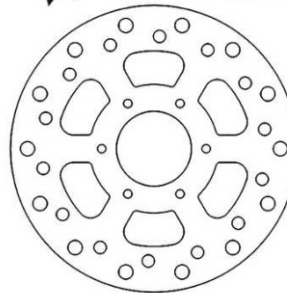

Ø 220/80.1/57.5 x 6.5 mm

Art.-Nr.	Ref	VP sFr
98.1253	<input type="text"/>	58.10

NEWFREN DF.4055

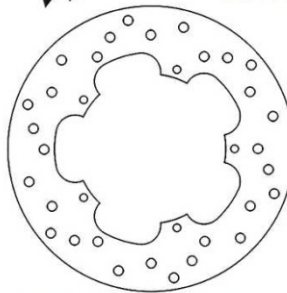

Ø 240/140/125 x 6.5 mm

Art.-Nr.	Ref	VP sFr
98.1255	<input type="text"/>	66.40

NEWFREN DF.4056

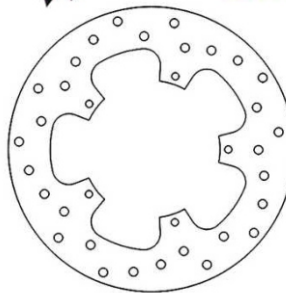

Ø 260/140/125 x 6.5 mm

Art.-Nr.	Ref	VP sFr
98.1233	<input type="text"/>	66.25

NEWFREN DF.4058

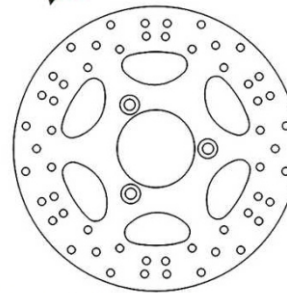

Ø 220/80/60 x 8.5 mm

Art.-Nr.	Ref	VP sFr
98.1235	<input type="text"/>	74.60

NEWFREN DF.4059

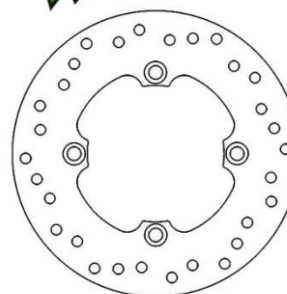

Ø 220/125/105 x 10.5 mm

Art.-Nr.	Ref	VP sFr
98.1259	<input type="text"/>	77.95

NEWFREN DF.4060

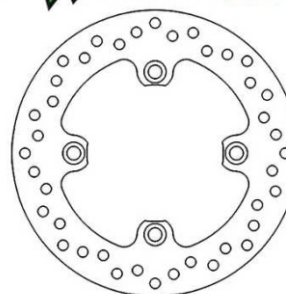

Ø 220/125/105 x 10.5 mm

Art.-Nr.	Ref	VP sFr
98.1260	<input type="text"/>	74.60

NEWFREN DF.4061

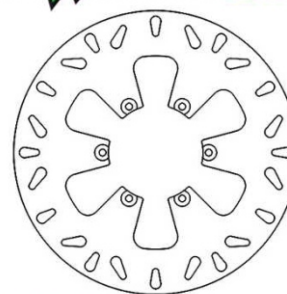

Ø 270/101/90 x 6.5 mm

Art.-Nr.	Ref	VP sFr
98.1236	<input type="text"/>	137.45



Scooter-Beläge + Backen + Kupplung + Glocke Plaquette + mâchoire-Scooter

98

NEWFREN DF.4064

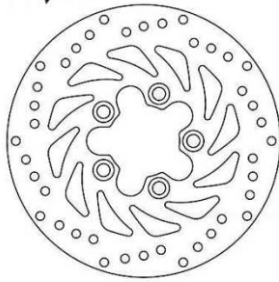

Ø 220/80/58 x 10.5 mm
Art.-Nr. 98.1240 Ref VP sFr 76.35

NEWFREN DF.4065

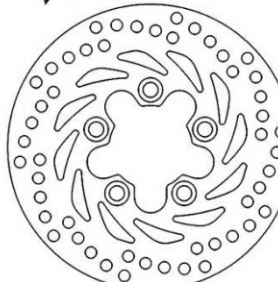

Ø 200/80/58 x 10.5 mm
Art.-Nr. 98.1241 Ref VP sFr 76.20

NEWFREN DF.4066

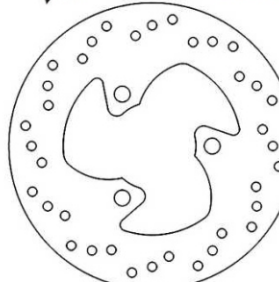

Ø 190/79.5/58.2 x 10 mm
Art.-Nr. 98.1243 Ref VP sFr 53.60

NEWFREN DF.4067

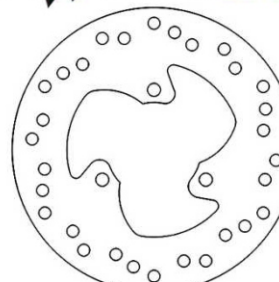

Ø 190/80/62 x 8.7 mm
Art.-Nr. 98.1244 Ref VP sFr 74.60

NEWFREN DF.4071

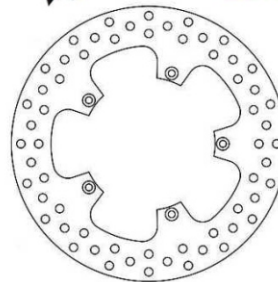

Ø 260/140/125 x 6.5 mm
Art.-Nr. 98.1271 Ref VP sFr 58.00

NEWFREN DF.4077

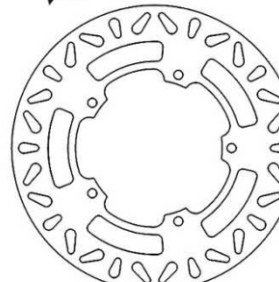

Ø 270/146/128.2 x 8.6 mm
Art.-Nr. 98.1245 Ref VP sFr 99.40

NEWFREN DF.4078

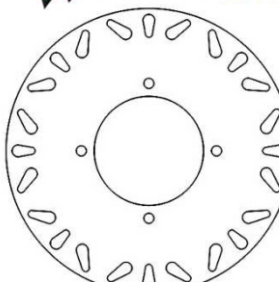

Ø 240/114/92.2 x 8.6 mm
Art.-Nr. 98.1246 Ref VP sFr 92.80

NEWFREN DF.4080

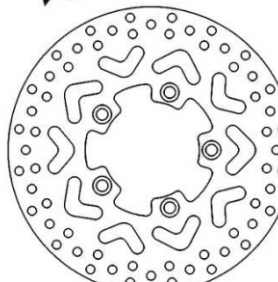

Ø 260/110.1/88.1 x 10.5 mm
Art.-Nr. 98.1280 Ref VP sFr 77.85

NEWFREN DF.4082

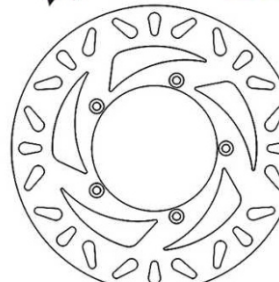

Ø 240/120/105.2 x 6.2 mm
Art.-Nr. 98.1281 Ref VP sFr 77.85

NEWFREN DF.4083



Ø 189.5/88.7/69.5 x 8.4 mm
Art.-Nr. 98.1282 Ref VP sFr 108.80

NEWFREN DF.4084

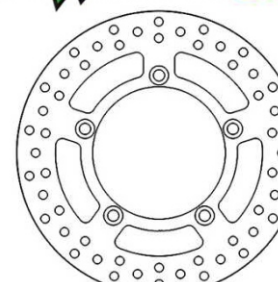

Ø 260/141.9/121.2 x 10.3 mm
Art.-Nr. 98.1284 Ref VP sFr 129.20

NEWFREN DF.4085

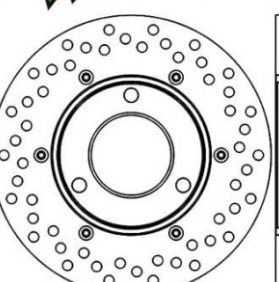

Ø 210/135/120.2 x 6.2 mm
Art.-Nr. 98.1285 Ref VP sFr 185.45



Scooter-Beläge + Backen + Kupplung + Glocke Plaquette + mâchoire-Scooter

98

NEWFREN DF.4088

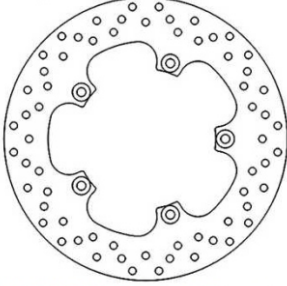

Ø 267/150/132 x 8.5 mm

Art.-Nr.	Ref	VP sFr
98.1288	<input type="text"/>	91.20

NEWFREN DF.4089

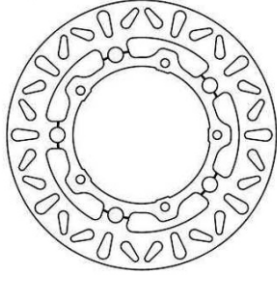

Ø 267/149.8/132.6 x 8.6 mm

Art.-Nr.	Ref	VP sFr
98.1289	<input type="text"/>	227.70

NEWFREN DF.4099

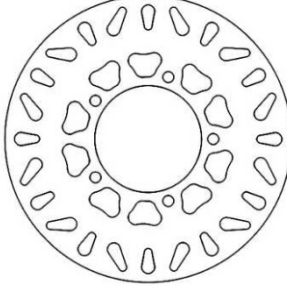

Ø 220/100/82 x 8.3 mm

Art.-Nr.	Ref	VP sFr
98.1299	<input type="text"/>	107.55

NEWFREN DF.4113

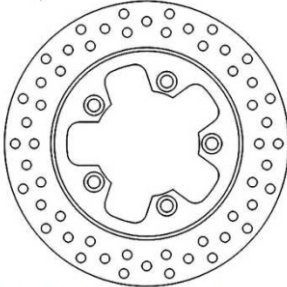

Ø 240/110/88 x 10.5 mm

Art.-Nr.	Ref	VP sFr
98.DF4113	<input type="text"/>	00.00

NEWFREN DF.4117



Ø 260/80/58.1 x 10.6 mm

Art.-Nr.	Ref	VP sFr
98.DF4117	<input type="text"/>	00.00

NEWFREN DF.4118



Ø 260/130/105.2 x 10.6 mm

Art.-Nr.	Ref	VP sFr
98.DF4118	<input type="text"/>	00.00

NEWFREN DF.4119



Ø 240/110/88 x 10.6 mm

Art.-Nr.	Ref	VP sFr
98.DF4119	<input type="text"/>	00.00

NEWFREN DF.5014

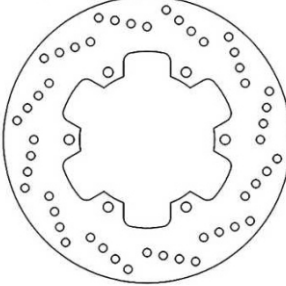

Ø 245/133/115.1 x 8.6 mm

Art.-Nr.	Ref	VP sFr
98.1314	<input type="text"/>	149.40

NEWFREN DF.5019



Ø 220/124/110.1 x 6.5 mm

Art.-Nr.	Ref	VP sFr
98.1319	<input type="text"/>	140.20

NEWFREN DF.5071

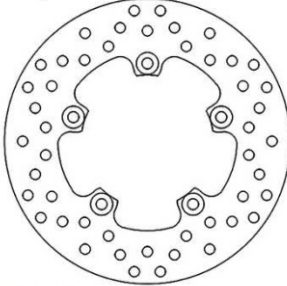

Ø 220/120/102 x 8.6 mm

Art.-Nr.	Ref	VP sFr
98.1371	<input type="text"/>	124.80

NEWFREN DF.5078

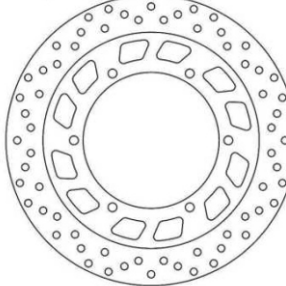

Ø 282/150/132.1 x 8.6 mm

Art.-Nr.	Ref	VP sFr
98.1378	<input type="text"/>	149.15

NEWFREN DF.5079

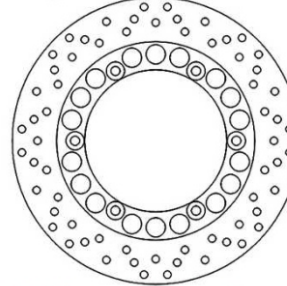

Ø 267/150/132.1 x 8.6 mm

Art.-Nr.	Ref	VP sFr
98.1379	<input type="text"/>	124.35



Scooter-Beläge + Backen + Kupplung + Glocke Plaquette + mâchoire-Scooter

98

NEWFREN FC.1331



Ø105mm
Art.-Nr. Ref
98.2005

650gr.
VP sFr
40.80

NEWFREN FC.1333



Ø105mm
Art.-Nr. Ref
98.2010

602gr.
VP sFr
40.80

NEWFREN FC.1334



Art.-Nr. Ref
98.2015

764gr.
VP sFr
142.40

NEWFREN FC.1345



Art.-Nr. Ref
98.2021

986gr.
VP sFr
56.00

NEWFREN FC.1347



Art.-Nr. Ref
98.2020

832gr.
VP sFr
77.30

NEWFREN FC.1349



Art.-Nr. Ref
98.2025

486gr.
VP sFr
40.80

NEWFREN G.0683



Ø 105 mm
Art.-Nr. Ref
98.2051

VP sFr
27.05

NEWFREN G.0684



Ø 107 mm
Art.-Nr. Ref
98.2052

VP sFr
33.60

NEWFREN G.0685



Ø 107 mm
Art.-Nr. Ref
98.2053

VP sFr
27.05

NEWFREN G.0686



Ø 106.5 mm
Art.-Nr. Ref
98.2054

VP sFr
51.05

NEWFREN G.0689



Ø 134 mm
Art.-Nr. Ref
98.2057

VP sFr
46.75

NEWFREN G.0690



Ø 120 mm
Art.-Nr. Ref
98.2058

VP sFr
41.00



Scooter-Beläge + Backen + Kupplung + Glocke Plaquette + mâchoire-Scooter

98

NEWFREN

Ø 9.5 x 30 mm

Art.-Nr.	Ref	VP sFr
98.2200	<input type="text"/>	15.20

NEWFREN

Ø 7.5 x 25 mm

Art.-Nr.	Ref	VP sFr
98.2201	<input type="text"/>	18.35

NEWFREN

Ø 7.5 x 30 mm

Art.-Nr.	Ref	VP sFr
98.2202	<input type="text"/>	18.35

Ø 15x12 mm

Art.-Nr.	Ø	Gewicht	VP sFr
98.2100	15x12 mm	3.2g	18.40
98.2101	15x12 mm	3.5g	18.40
98.2102	15x12 mm	3.7g	18.40
98.2103	15x12 mm	4.2g	18.40
98.2104	15x12 mm	4.8g	18.40
98.2105	15x12 mm	5.4g	18.40
98.2106	15x12 mm	6.0g	18.40
98.2107	15x12 mm	6.5g	18.40
98.2108	15x12 mm	6.8g	18.40
98.2109	15x12 mm	7.2g	18.40
98.2110	15x12 mm	7.8g	18.40
98.2111	15x12 mm	8.3g	18.40
98.2112	15x12 mm	8.7g	18.40
98.2113	15x12 mm	9.2g	18.40

Ø 16x13 mm

Art.-Nr.	Ø	Gewicht	VP sFr
98.2160	16x13 mm	2.7g	20.00
98.2161	16x13 mm	3.0g	20.00
98.2162	16x13 mm	3.3g	20.00
98.2163	16x13 mm	3.6g	20.00
98.2164	16x13 mm	3.9g	20.00
98.2165	16x13 mm	4.1g	20.00
98.2166	16x13 mm	4.4g	20.00
95.289927	16x13 mm	8.5g	20.00

Ø 17x12.3 mm

Art.-Nr.	Ø	Gewicht	VP sFr
98.2180	17x12.3 mm	4.0g	21.60
98.2181	17x12.3 mm	4.5g	21.60
98.2182	17x12.3 mm	5.0g	21.60
98.2183	17x12.3 mm	5.5g	21.60
98.2184	17x12.3 mm	6.0g	21.60
98.2185	17x12.3 mm	6.5g	21.60
98.2186	17x12.3 mm	7.0g	21.60

Ø 19x13.7 mm

Art.-Nr.	Ø	Gewicht	VP sFr
98.2195	19x13.7 mm	12.0g	28.65

Ø 19x17 mm

Art.-Nr.	Ø	Gewicht	VP sFr
98.2002	19x17 mm	7.4g	30.10

Ø 20x17 mm

Art.-Nr.	Ø	Gewicht	VP sFr
98.2000	20x17 mm	14.0g	35.20
95.485713	20x17 mm	14.0g	25.20



Scooter-Beläge + Backen + Kupplung + Glocke Plaquette + mâchoire-Scooter

98



Ø 20.9x17 mm

Art.-Nr.	Ø	Gewicht	VP sFr
98.2006	20.9x17 mm	10.7g	28.80
98.2004	20.9x17 mm	11.0g	46.40



Ø 23x18 mm

Art.-Nr.	Ø	Gewicht	VP sFr
98.2008	23x18 mm	25.0g	47.85

